

# Operating and Maintenance Manual



## PG 55 E/70E/90E/110E



### **Weber Maschinentechnik GmbH**

Im Boden 5 - 8, 10

57334 Bad Laasphe-Rückershausen / Germany

Telephone +49 (0) 27 54 / 398-0

Fax +49 (0) 27 54 / 398-101

E-Mail: [info@webermt.de](mailto:info@webermt.de)

Web: [www.webermt.de](http://www.webermt.de)



## Table of contents

|                                   |    |
|-----------------------------------|----|
| Introduction                      | 4  |
| Safety guidelines                 | 5  |
| Graphic presentation              | 8  |
| Device description                | 9  |
| Technical data                    | 10 |
| Activities prior to starting work | 12 |
| Starting                          | 13 |
| Troweling                         | 14 |
| Shutting down                     | 16 |
| Maintenance overview              | 17 |
| Maintenance work                  | 18 |
| Operating fluids and fill levels  | 20 |
| Troubleshooting                   | 20 |
| Storage                           | 21 |
| Contact addresses                 | 23 |

## **Introduction**

This operating and maintenance manual is designed to facilitate familiarization with your concrete trowel machine, and to enable you to maintain the compactor and use it for its intended purpose. When complying with the instructions in the operating and maintenance manual you help avoid hazards, reduce repair and downtime costs, and increase the reliability and service life of your concrete trowel machine.

This operating and maintenance manual must always be available at the implementation site of the concrete trowel machine.

If necessary you can obtain additional information from your authorized WEBER dealer, or you can obtain information from one of the contact addresses on the last page.

The valid conformity declaration is enclosed with every machine delivery.

## Safety guidelines

### General

All safety instructions must be read and complied with, non-compliance results in

- Danger to life and limb of the user
- Impairments to the machine or other property.

In addition to the operating manual, the accident-prevention regulations in the country where the appliance is used must be complied with.

### Intended use

The concrete trowel machine should only be used in technically faultless condition, as intended, in a safety-conscious and hazard-conscious manner, in compliance with the instructions in the operating manual. Malfunctions that impair safety must be eliminated without delay.

Our PG concrete trowel machines are designed exclusively for troweling

- concrete
- screed.

Any other use of the trowel machine is considered to be non-intended use, for which the customer is exclusively responsible. All liability is rejected if damage occurs due to non-compliance with this provision. This risk is borne solely by the user.

### Easily foreseeable misuse

Any use for which the machine is not intended.

### Operation

Trowel machines are only permitted to be operated by suitable persons of at least 18 years of age. Operators must be instructed in how to guide the trowel machine by the owner or by owner's assigned personnel.





The machine operator must comply with traffic regulations. If instructions that affect safety are given by third parties, then the operator must be authorized to reject these instructions.

 Unauthorized persons are forbidden from being in the area of the trowel machine during the troweling process.

### Protective equipment

This machine is capable of exceeding the permissible sound level of 80 dB(A). The owner might also face additional dangers when using the machine. Precautionary action must, therefore, be taken.

Protective equipment includes:

-  Hearing protection
-  Hard hat
-  Safety shoes
-  Protective gloves

## Operation

Prior to starting work the owner of the trowel machine must be familiar with the working environment. The work environment includes obstacles in the work and traffic area, the bearing capacity of the ground, as well as the necessary safeguarding of the construction site in the area adjacent to public traffic; and it includes compliance with traffic regulations.

The trowel machine should only be operated when the protective fixtures are mounted.

The protective fixtures must all be in functional condition.

At least once per shift the trowel machine must be checked for apparent defects. If there are apparent defects then operation of the trowel machine must be stopped immediately, and the responsible person must be informed. Prior to restarting, trowel machine malfunctions that have occurred must be corrected.

Always maintain adequate clearance to the edges of pits and embankments.

After work has been concluded, secure the trowel machine in accordance with statutory regulations, particularly in the area of public traffic surfaces.

The device must not be operated in heavy rain. Observe the degree of protection of the electrical components.

## Maintenance and repair work

Only use **original Weber spare parts** to ensure reliable and safe operation for maintenance or repair work.

Adjusting tasks, maintenance tasks, and inspection tasks must be carried out on schedule as specified in this operating and maintenance manual. These activities should only be executed by instructed personnel.

For repair, maintenance, or inspection work the engine of the trowel machine must be safeguarded against unintentional starting.

For maintenance and repair tasks the trowel machine must be placed on a level and stable substrate and must be secured from rolling off or tipping over.

Heavy components and assemblies must be secured to and lifted by hoisting machines that can bear their weight when they are replaced. Ensure that no hazard is caused by raising components or assemblies.

Do not position yourself or work under suspended loads.



If lubricating oils and fuel come into contact with skin, they can cause skin cancer.

Upon contact with the skin, clean affected skin with suitable cleaning agent without delay.

## Electrical voltage safety

It is prohibited to switch the trowel machine on or off by removing or inserting the connector plug into or from the power outlet.

The connecting cable of the trowel machine must not be used to pull the plug out of the power outlet. Protect electric cables against heat, oil and sharp edges.

Operating the trowel machine in an explosive atmosphere is prohibited.

When taking a break, shut off the trowel machine and set it down in such a way that it cannot roll away or fall down inadvertently.

Every time you interrupt your work, you also need to disconnect the trowel machine from the mains by pulling the power plug.

### **Behavior in case of faults**

After coming into contact with high-voltage current lines:

- Do not abandon the machine
- Warn third parties against approaching and touching the machine
- Have voltage cut off
- Wait until the line is powered off

### **Inspection**

German social accident insurance (DGUV) regulations mandate that DGUV directive 3 be applied during the testing of electrical installations and equipment.

Trowel machines must be inspected in accordance with appropriate implementation conditions and operating conditions, as needed; however, an inspection to ensure operationally safe status must be performed by an expert at least once a year. The results of the inspection must be recorded in writing and must be stored at least until the next inspection.

### **Cleaning work**

Cleaning tasks should only be executed in areas that are suitable and have been approved for this purpose (oil separator amongst others).

### **Disposal**

All operating fluids and auxiliary materials must be disposed of in an environmentally-compatible manner in accordance with country-specific regulations.

**Important information for operating and maintenance personnel is marked by pictograms.**



Warning against irritants or materials hazardous to health



Warning against a hazardous place



Warning against a suspended load



Wear ear protection



General regulation



Environmental protection



Hard hat



Safety shoes



Protective gloves

## Graphic presentation

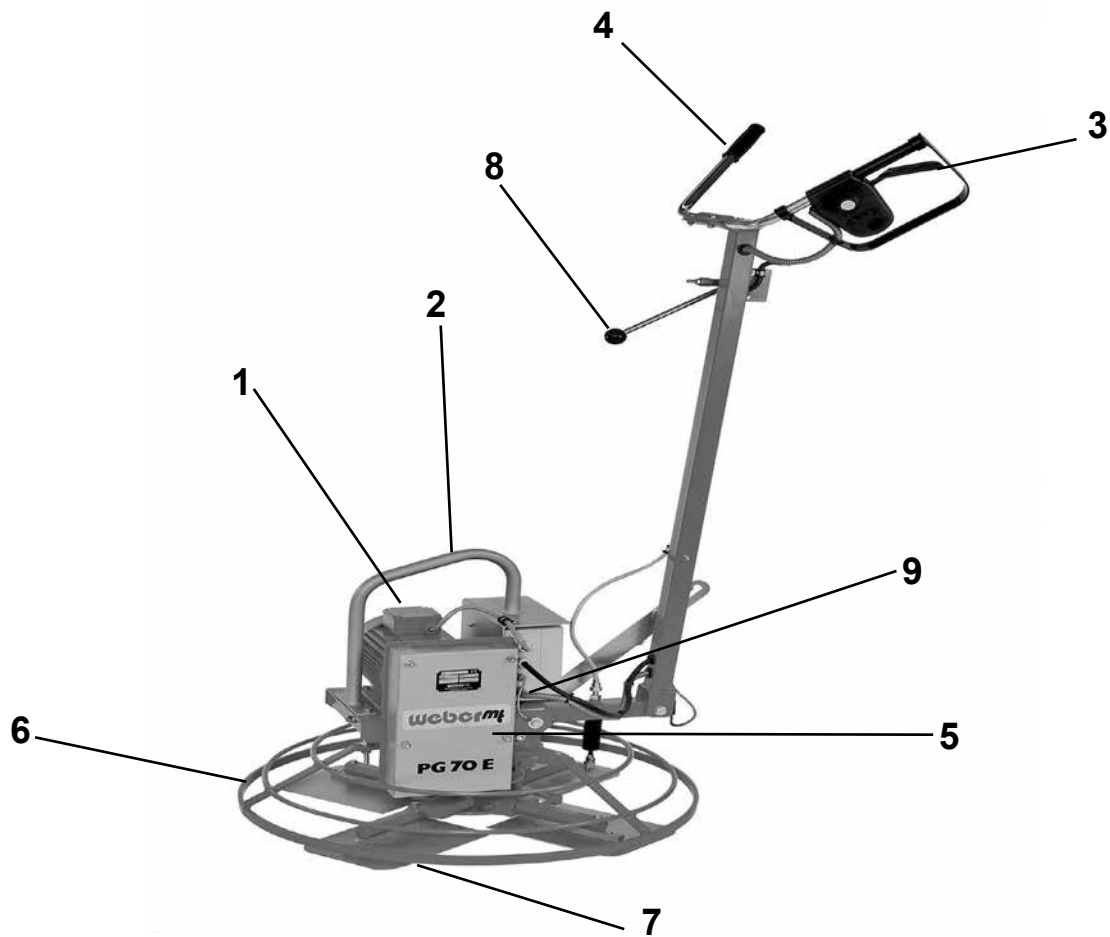

### Overall view PG

- 1 Engine
- 2 Protective frame
- 3 On/Off switch
- 4 Handle
- 5 V-belt guard
- 6 Protective cage
- 7 Troweling blades
- 8 Adjusting lever/troweling blade adjuster
- 9 Hearing protection (sticker) 
- 10 On/Off switch
- 11 Main switch



## **Device description**

The trowel machines of types PG 55 E through PG 110 E-2 are hand-guided machines that are used to trowel and grind concrete and screed surfaces.

## **Drive**

The machine is powered by an electric motor.

## **Function**

The force generated by the engine is transmitted mechanically to the gearbox of the trowel machine by a V-belt pulley and a V-belt. The troweling blades and the troweling pan attached to the gearbox smooth the concrete or screed.

## **Operation**

The electric motor is switched to operational readiness using the On/Off switch built into the control cabinet of the trowel machine. You switch electric motor on and start the troweling process by pressing the On/Off switch located at the manual guidance rod. The adjusting lever fitted at the manual guidance rod is used to infinitely adjust the angle of the troweling blades.

## Technical data

|   | PG 55 E  | PG 70 E  | PG 90 E  | PG 90-2 E | PG 110 E | PG 110-2 E |
|---|----------|----------|----------|-----------|----------|------------|
| <b>Weight</b>   |          |          |          |           |          |            |
| Operating weight CECE in kg                                       | 48       | 76       | 87       | 87        | 93       | 95         |
| <b>Dimensions</b>   |          |          |          |           |          |            |
| Overall length (in mm)  | 1575     | 2166     | 2241     | 2241      | 2366     | 2366       |
| Protective ring diameter (in mm)                                  | 595      | 786      | 936      | 936       | 1186     | 1186       |
| Height with folded manual guidance rod (in mm)                    | 900      | 900      | 900      |           | 900      | 900        |
| Operating diameter (in mm)  | 563      | 750      | 900      | 900       |          |            |
| <b>Drive</b>  |          |          |          |           |          |            |
| Engine  | Electric | Electric | Electric | Electric  | Electric | Electric   |
| Performance at operating speed in accordance with ISO 3046-1 (kW) | 1.5      | 2.2      | 3.0      | 3.0       | 3.0      | 3.0        |
| <b>Performance characteristics</b>                                |          |          |          |           |          |            |
| Rotation (1/min)  | 100      | 95       | 95       | 48/95     | 75       | 37/78      |
| Gear ratio  | 19,5     | 19,5     | 19,5     | 19,5      | 19,5     | 19,5       |
| Degree of protection  | IP 44    | IP 44    | IP 44    | IP 44     | IP 44    | IP 44      |

|  | PG 55 E | PG 70 E | PG 90 E | PG 90-2 E | PG 100 E | PG 100-2 E |
|--|---------|---------|---------|-----------|----------|------------|
| <b>Vibration values</b>  |         |         |         |           |          |            |
| Root-mean-square acceleration value for hand-arm vibration ascertained in accordance with EN 500 in m/s <sup>2</sup>   |         |         |         |           |          |            |
| Troweling blades, position flat  | 5.9     | 12.5    | 12.5    | 12.5      | 10.4     | 10.4       |
| Troweling blades, position slanted   | 3.1     | 8.5     | 8.5     | 8.5       | 5.7      | 5.7        |
|  In accordance with directive 2006/42/EC, complying with the vibration values is the owner's responsibility. |         |         |         |           |          |            |

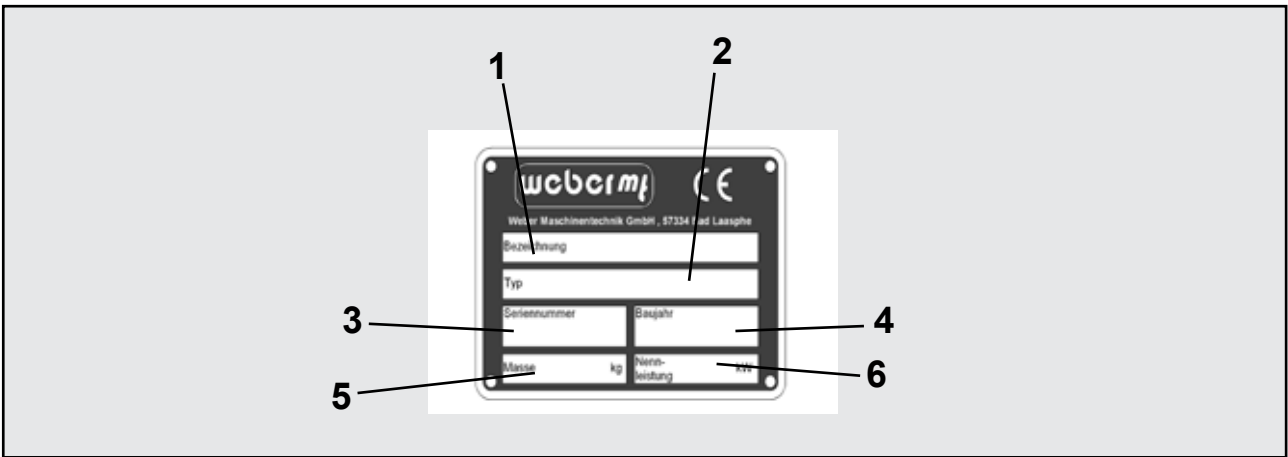

**1 Description**

.....

**3 Serial number**

.....

**5 Mass**

.....

**2 TYPE**

.....

**4 Year of construction**

.....

**6 Rated power kW**

.....

## Activities prior to starting work

### Transport

-  When transporting the trowel machine on a vehicle, secure it with suitable restraints.

Arrest the manual guidance rod (1) with the tommy screw (2).

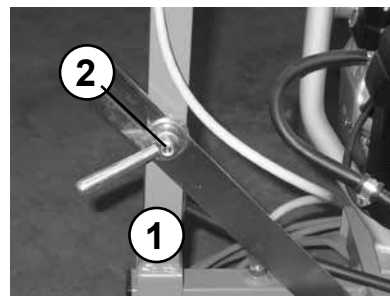

Attach the crane hook (1) to the protective frame and lift the machine onto the means of transport selected.

-  Only use lifting machines with a minimum bearing capacity of 150 kg.

-  Do not step under suspended loads.



### Starting

Connect the power cable to the mains.

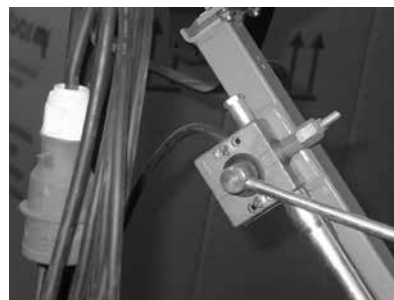

### PG 70 E/PG 90 E/PG 100 E

"Set the switch (1) to one of the two positions. If the machine cannot be switched on or off at the manual guidance rod, this will be due to a rotating field error.

In this case, set the switch (1) to the other position. After waiting for 5 s. You will be able to switch the machine on."



## Troweling

Use the adjusting lever (1) to set the troweling blade to the desired position.

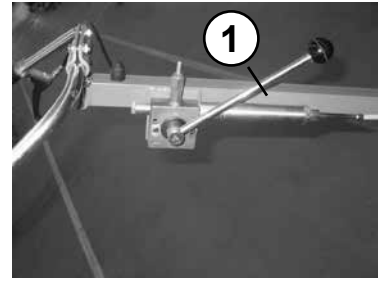

Press the locking button (1) and push the lever (2) up.

 Only run machine within reach of the manual guidance rod.

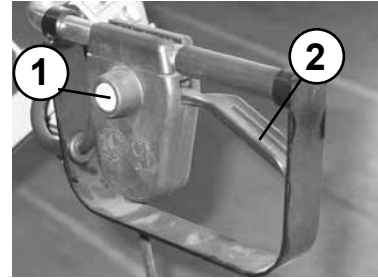

## Forward

Push the machine forward using the manual guidance rod (1).

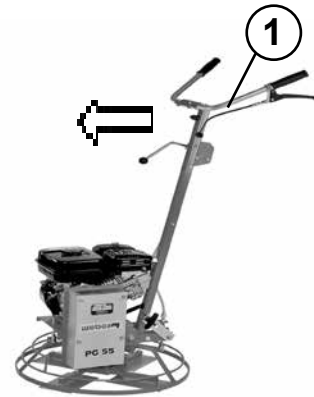

## Reverse

Pull the machine backward using the manual guidance rod (1).



## Move to the left

Lift the machine up slightly using the manual guidance rod (1).

 The frictional forces in front of and behind the drive shaft are increased and decreased, respectively. A clockwise rotational movement will cause the machine to move to the left.



### Move to the right

Push the machine down slightly using the manual guidance rod (1).



The machine is caused to move to the right by the shift of frictional forces at the rear (see above).



### Troweling on the spot

Use the manual guidance rod (1) to keep the machine in the horizontal position.



The frictional forces cancel each other out, causing the machine to keep moving on the spot.



At obstructions (walls, pits, etc.), ensure that no one can be caught between the machine and the obstruction; or ensure that the machine does not slip into the pit.

## Possible applications

The trowel machine can be used for the machine-assisted troweling of concrete surfaces, e.g. industrial floors, roller skate rinks, parking decks, sewage plants, basement and garage floors, screed surfaces, etc.

## Pre-troweling

 The surface to be smoothed is pre-troweled with the troweling pan (1).

The right time for pre-troweling has come when a person walking on the cured concrete surface no longer leaves footprints behind.

Pre-troweling involves the process of grinding off any unevenness caused by pouring the concrete and rubbing the ground-off material into any cavities and recesses that may exist in the floor.

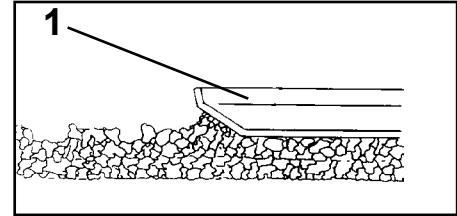

The concrete surface is leveled. During this process, the concrete surface is compacted due to a thorough rearrangement of the aggregate particles. Any shrinkage cracks and pores that may have been brought about by escaping air are sealed. Minimum size particles shift and settle in the cavities between the larger aggregates. The shifted particles push any retained water to the surface, where it evaporates.

The number of passes required for pre-troweling cannot be specified exactly as this number is influenced by various factors (e.g. concrete consistency, ambient temperature, humidity, etc.). Under normal conditions, however, one to two passes will suffice.

## Fine troweling

 Fine troweling requires that the surfaces have been pre-treated with the troweling pan.

Fine troweling is applied when no more moisture can be detected on the surface. For fine troweling the troweling pan is substituted for the troweling blades.

The troweling blades (1) rotate across the concrete surface (2) at relatively high pressure and at a certain blade angle ( $\alpha$ ).

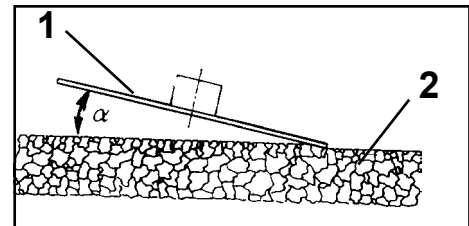

For the first few passes, the blade angle ( $\alpha$ ) is usually kept small. The blade angle increases with the number of passes. A key factor during this process is the weight of the machine. The wider the angle of the troweling blades and the higher the weight of the machine acting on the troweling blades are, the harder and, thus, more resistant to wear the surface is.

 It is recommended to use a second trowel machine for surfaces with an area exceeding 200 sqm.

The first machine is then used for pre-troweling with a troweling pan.



The second machine is fitted with troweling blades and used for fine troweling.

## Shutting down

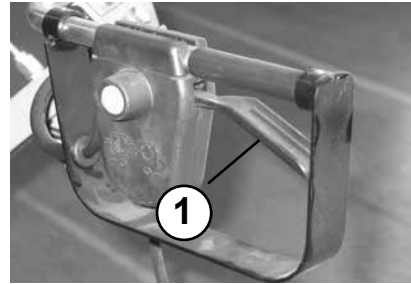
Release the lever (1).



Turn the switch to position “0”.

-  During breaks – even if they are short – the machine must be shut down.
-  Parked devices that represent an obstacle must be safeguarded through conspicuous measures.
-  Disconnect the connecting cable from the mains by pulling the connector plug.

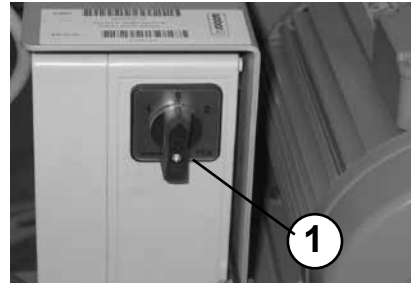

## Cleaning the machine

Observe the device’s protection class when cleaning the machine.

None of the electrical components (engine, switches, etc.) may be cleaned with a high-pressure cleaner.





## Maintenance overview

| Maintenance interval               | Maintenance point | Maintenance activity                             |
|------------------------------------|-------------------|--|
| After the first 25 operating hours |                   | – Re-tighten all accessible threaded connections |
| every 150 operating hours          | Gearbox           | – Change semi-fluid grease                       |

 Work must be carried out using regulation tools, and the operating and maintenance manual must be complied with for all work.

 All maintenance work: Select a collection vessel that is large enough to prevent oil from spilling onto the ground. Dispose of waste oil in an environmentally friendly manner (regulation on waste oils).

 Dispose of oils, greases, cloths soaked in oil, and replaced parts with oil on them in an environmentally friendly manner.

 If lubricating oils and fuel come into contact with skin, they can cause skin cancer. Upon contact with the skin, clean affected skin with suitable cleaning agent without delay.

 If accessible during maintenance, check the condition and stability of all screws.

## Maintenance work

### Checking the V-belt

Remove the V-belt guard (1).

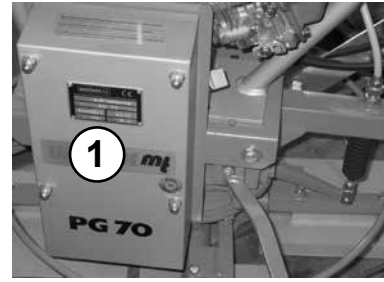

Check the V-belt (1) for cracks, damaged flanks, and wear.

If there is excessive wear – replace the V-belt as specified in the repair manual.

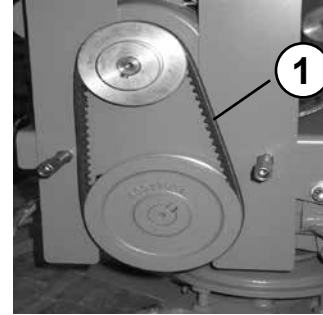

## Troubleshooting

| Fault   | Possible cause   | Remedy   |
|---|--|--|
| <b>Machine does not start</b>   | Operating error  | Execute the start process as prescribed  |
| <b>The speed of the troweling blades/troweling pan is too low</b>                               | V-belt defective   | Change V-belt  |
| <b>A creepage current can be detected on the conductive parts of the unit (leakage current)</b> | Grounding conductor not present<br>Ground fault circuit interrupter missing/defective<br>Power distribution on site not grounded | Check/replace connecting cable<br><br>Check/replace ground fault circuit interrupter<br>Check power distribution on site, provide for proper grounding of power distribution on site |

## Actions to be taken before long-term storage (longer than a month)

|   |   |
|---|---|
| <b>Total machine</b>  | <ul style="list-style-type: none"><li>– Clean thoroughly</li><li>– Check for leaks</li><li>– If there are leaks, correct defects</li></ul>  |
| <b>Fuel tank</b>  | <ul style="list-style-type: none"><li>– Empty fuel and fill with clean fuel up to the lower edge of filler neck</li></ul>   |
| <b>Engine</b>   | <ul style="list-style-type: none"><li>– Check oil level, if necessary fill to upper oil-level mark</li><li>– Check air filter, clean, replace if necessary</li><li>– Check fuel filter, change if necessary</li></ul> |
| <b>All bare parts/gas lever/accelerator control cable/fastening bolts</b> | <ul style="list-style-type: none"><li>– Oil/grease</li></ul>  |



If the machine is to be stored for longer than six months, then contact the Weber service organization to discuss additional measures.







## Weber Maschinentchnik GmbH

If you have questions, suggestions, problems, etc. please contact us at one of the following addresses:

|                   |   |                                |  |
|-------------------|---|--------------------------------|--|
| in Germany        | WEBER Maschinentchnik GmbH<br>Im Boden 5 – 8, 10<br>57334 Bad Laasphe-Rückershausen | Telephone<br>Fax<br><br>E-mail | +49 (0) 2754 - 398-0<br>+49 (0) 2754 - 398101 – Switch-board<br>+49 (0) 2754 - 398102 – spare-parts directline<br><br>g.voelkel@webermt.de |
| in France         | WEBER Technologie SARL<br>14' rue d' Arsonval<br>69680 Chassieu                     | Telephone<br>Fax<br><br>E-mail | +33 (0) 472 - 791020<br>+33 (0) 472 - 791021<br><br>france@webermt.com   |
| in Poland         | WEBER Maschinentchnik<br>Sp. zo.o.<br>Ul. Jeziorki 86<br>02-863 Warszawa            | Telephone<br>Fax<br><br>E-mail | +48 (0) 22 - 739 70 - 80<br>+48 (0) 22 - 739 70 - 81<br>+48 (0) 22 - 739 70 - 82<br><br>info@webermt.com.pl                                |
| in Czech Republic | WEBER MT s.r.o.<br>V Pískovně 2054<br>278 01 Kralupy nad Vltavou                    | Telephone<br><br>E-mail        | +42 (0) 776 222 216<br>+42 (0) 776 222 261<br><br>info@webermt.cz  |
| in USA and Canada | WEBER MT<br>4717 Broadmoor Ave. SE Suite B<br>Grand Rapids, MI 49512                | Telephone<br>Fax<br><br>E-mail | +1(207) - 947 - 4990<br>+1(207) - 947 - 5452<br><br>sales@webermt.us<br>service@webermt.us   |

**> Vibration plates**

**> Vibrating tampers**

**> Vibration rollers**

**> Joint cutters**

**> Internal vibrators and converters**

**> Rollers**



**Weber MASCHINENTECHNIK GmbH**

**Im Boden**

**57334 Bad Laasphe-Rückershausen**

**Telephone +49 (0) 27 54 / 398-0 – Telefax +49 (0) 27 54 / 398-101**