

Operating and Maintenance Manual



SM 62-2 HD

0401502

Table of contents

Introduction	4
Safety guidelines	5
Graphic presentation	8
Device description	9
Technical data	10
Activities prior to starting work	12
Starting	13
Cutting	14
Shutting down	15
Maintenance overview	16
Maintenance work	17
Operating fluids and fill levels	19
Troubleshooting	19
Storage	20

Introduction

This operating and maintenance manual is designed to facilitate familiarization with your joint cutter, and enable you to maintain it and use it for its proper purpose.

When complying with the instructions in the operating and maintenance manual you help to avoid hazards, reduce repair and downtime costs, and increase the reliability and service life of your joint cutter.

This operating and maintenance manual must always be available where the joint cutter is used.

If necessary you can obtain additional information from your authorized WEBER dealer, or you can obtain information from one of the contact addresses on the last page.

You can obtain information on the assembled Honda petrol engine and find a spare-part list for it at **www.honda-engines-eu.com**.

The valid conformity declaration is enclosed with every machine delivery.

Safety guidelines

General

All safety instructions must be read and complied with, non-compliance results in

- Danger to life and limb of the user
- Impairments to the machine or other property.

In addition to the operating manual, the accident-prevention regulations in the country where the appliance is used must be complied with.

Intended use

The joint cutter should only be used if it is in a technically faultless condition, for its proper purpose, in a safety-conscious and hazard-conscious manner, and in compliance with the instructions in the operating manual. Malfunctions that impair safety must be eliminated without delay.

The joint cutter type SM 62-2 is only intended for cutting:

- bituminous material (road surfaces); and
- concrete surfaces.

Any other use of the joint cutter is considered to be improper use for which the owner shall be exclusively responsible. All liability is rejected if damage occurs due to non-compliance with this provision. This risk is borne solely by the user.

Easily foreseeable misuse

Any use for which the machine is not intended.

Operation

Joint cutters must only be operated by suitable personnel of at least 18 years of age. Operators must be instructed by the owner or by the owner's personnel in how to guide the joint cutter.

The machine operator must comply with traffic regulations. If instructions that affect safety are given by third persons, then the operator must be authorized to reject these instructions.



Unauthorized persons are forbidden from being in the area of the joint cutter during the cutting process.

Protective equipment

This machine is capable of exceeding the permissible sound level of 80 dB(A). The owner might also face additional dangers when using the machine. Precautionary action must, therefore, be taken.

Protective equipment includes:



Hearing protection



Hard hat



Safety shoes



Protective gloves

Operation

Prior to starting work the owner of the joint cutter must be familiar with the working environment. The working environment includes obstacles in the work and traffic area, the bearing capacity of the ground, as well as the necessary safeguarding of the construction site in the area adjacent to public traffic; and it also includes compliance with traffic regulations.

The joint cutter should only be operated when all the protective fixtures are mounted. The protective fixtures must all be in functional condition.

At least once per shift the joint cutter must be checked for defects that can be detected from the outside. If defects are found then operation of the joint cutter must be stopped immediately and the responsible person must be informed. Prior to restarting, joint cutter malfunctions that have occurred must be corrected.

Operation under difficult conditions

 Never inhale the exhaust gas; it contains carbon monoxide, a colorless and odorless gas that is extremely hazardous, which, if inhaled even briefly, can cause unconsciousness and death.

Therefore, never operate the engines in enclosed areas or in areas that are poorly ventilated (tunnels, caves, etc.). Exercise particular caution when operating the engine in the vicinity of people and livestock.

Maintenance and repair work

Only use **original Weber spare parts** for maintenance or repair work to ensure reliable and safe operation.

Hydraulic hose lines must be checked at regular intervals in accordance with standard engineering practice, or they must be replaced at appropriate intervals, even if no signs of safety-relevant defects are present.

Adjusting tasks, maintenance tasks, and inspection tasks must be carried out on schedule as specified in this operating and maintenance manual. These activities should only be executed by trained personnel.

For repair, maintenance, or inspection work the engine of the joint cutter must be prevented from being started unintentionally.

All pressurized lines, particularly hydraulic lines and lines of the injection system of the drive motor must be depressurized before performing maintenance or repair tasks.

For maintenance and repair tasks the joint cutter must be placed on a level and stable surface and must be secured from rolling off or tipping over.

Heavy components and assemblies must be secured to and lifted by hoisting machines that can bear their weight when they are replaced. Ensure that no hazard is caused by raising components or assemblies.

Do not position yourself or work under suspended loads.

 If lubricating oils and fuel come into contact with skin, they can cause skin cancer. Upon contact with the skin, clean affected skin with suitable cleaning agent without delay.

Inspection

Joint cutters must be inspected in accordance with the corresponding conditions of use and operation as needed; however, an inspection to ensure they are operationally safe must be performed by an expert at least once a year. The results of the inspection must be recorded in writing and must be stored at least until the next inspection.

Cleaning work

Prior to cleaning the joint cutter with a high-pressure cleaner, protect all accessible energized switches, cable connections, etc. against water penetration by masking them off.

Cleaning tasks should only be executed in areas that are suitable and have been approved for this purpose (oil separator amongst others).

Disposal

All operating fluids and auxiliary materials must be disposed of in an environmentally-compatible manner in accordance with country-specific regulations.

Important information for operating and maintenance personnel is marked by pictograms.



Warning against irritants or materials hazardous to health



Warning against a hazardous place



Warning against a suspended load



Wear ear protection



General regulation



Environmental protection



Hard hat



Safety shoes



Protective gloves

Graphic presentation

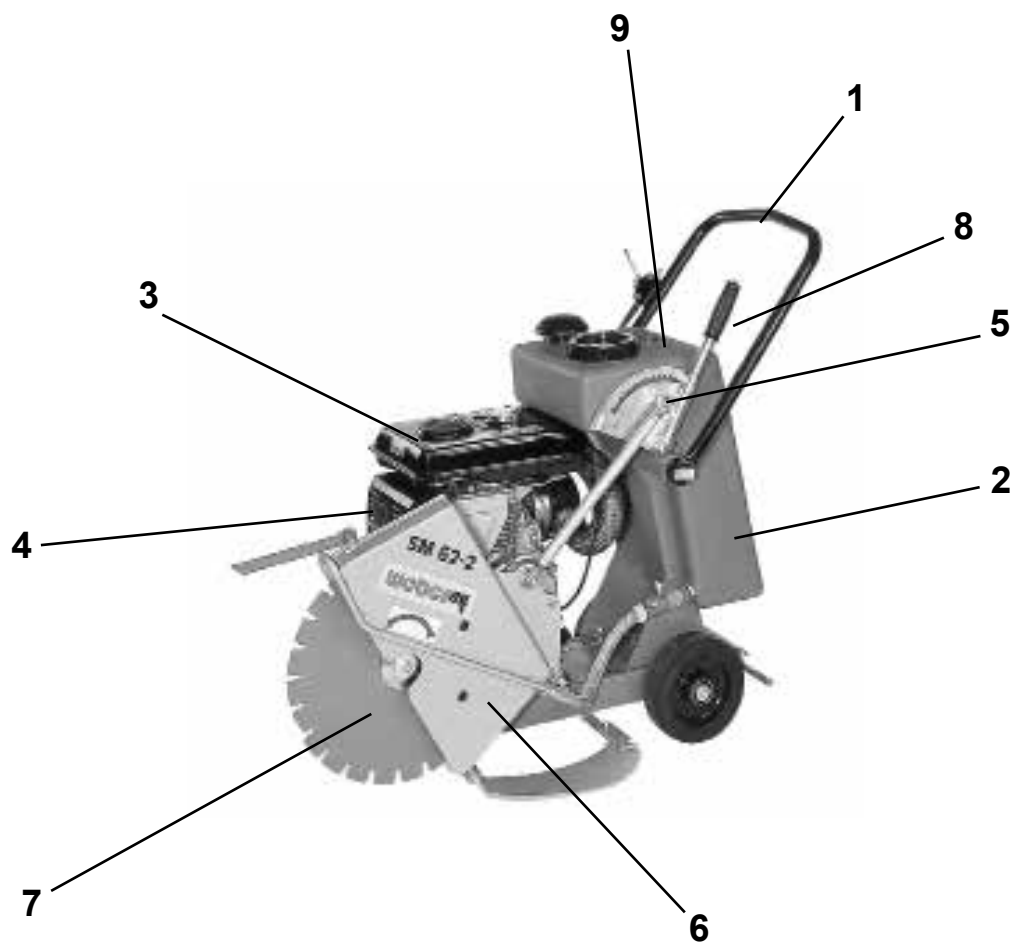

Overall view of the SM 62-2

- 1 Manual guidance rod/transport handle
- 2 Water tank
- 3 Fuel tank
- 4 Engine
- 5 Scale for cutting depth
- 6 Cutting disk protection

- 7 Cutting disk
- 8 Cutting depth adjustment lever
- 9 Hearing protection (sticker) 

Device description

The joint cutter of type SM 62-2 is used for cutting work on roads and buildings.

Drive

The unit is powered by an air-cooled Honda gasoline engine.

Force is transferred to the cutting shaft mechanically via a ribbed V-belt.

Operation

The cutting depth is set with the cutting depth adjustment lever and can be controlled on the cutting depth scale.

The supply of water from the water tank serves to bind with the dust during cutting with dry cutting disks. The quantity of water is not sufficient for cooling wet cutting disks.

Start the Honda gasoline engine with the attached reversing starter.

The engine speed is regulated with the accelerator attached to the handle.

The cutting machine is steered and moved forwards and backwards at the handle.

Technical data

	SM 62-2
Weight	
Operating weight CECE in kg	86
Dimensions	
Overall length (in mm)	1140
Overall width (in mm)	490
Height with manual guidance rod (in mm)	920
Cutting disk diameter (max. mm)	400
Disk bore (mm)	25.4
Drive	
Engine manufacturer	Honda
Type	GX 390
Performance at operating speed in accordance with ISO 3046-1 (kW)	7.0
Combustion process	4-stroke gasoline
Operating speed (m/min)	3600
Cutting disk	
Disk speed (rotations per minute)	2830
Cutting speed (m/s)	59.3
Cutting depth (mm)	145

	SM 62-2
Noise emissions in accordance with 2000/14/EC	
Sound pressure level L_{PA} ascertained in accordance with EN 500, in dB (A)	86
Sound power level L_{WA} ascertained in accordance with EN ISO 3744 and EN 500, in dB (A)	105
Vibration values	
Root-mean-square acceleration value for hand-arm vibration ascertained in accordance with EN 500 in m/s^2	10.3
 In accordance with directive 2006/42/EC, complying with the vibration values is the owner's responsibility.	

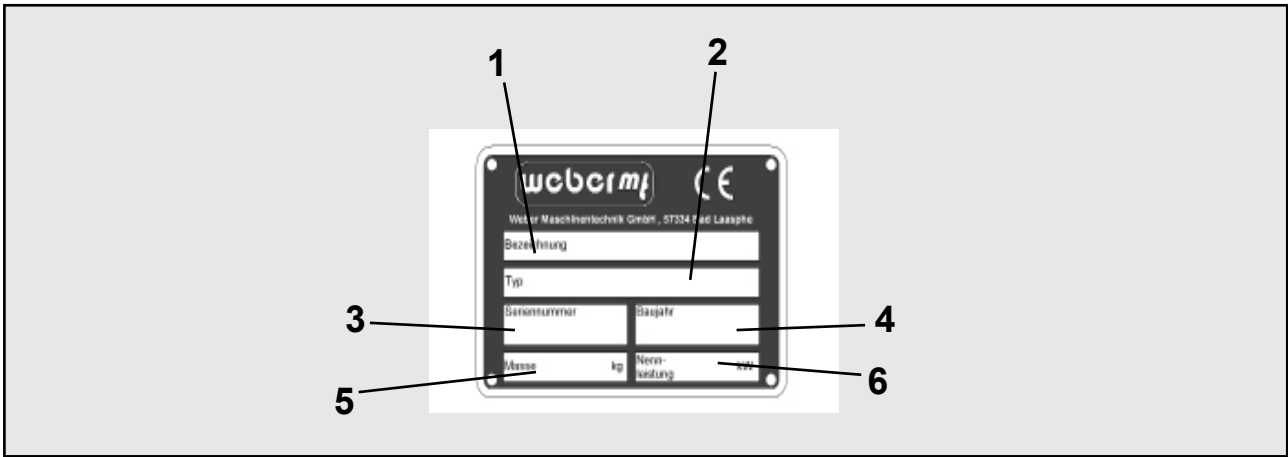

1 Description

.....

3 Serial number

.....

5 Mass

.....

2 TYPE

.....

4 Year of construction

.....

6 Rated power kW



.....

Activities prior to starting work

Transport

-  When transporting the joint cutter on a vehicle, secure it with suitable restraints.

Attach the crane hook (1) to the handle (2) and lift the machine onto the means of transport selected.

-  Only use lifting machines with a minimum bearing capacity of 200 kg.
-  Do not step under suspended loads.

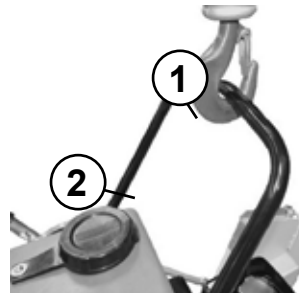

Checking the engine oil level

Pull the oil dipstick (1) out of the crankcase.

-  Insert the oil dip stick in the oil filler neck, but do not screw it in.

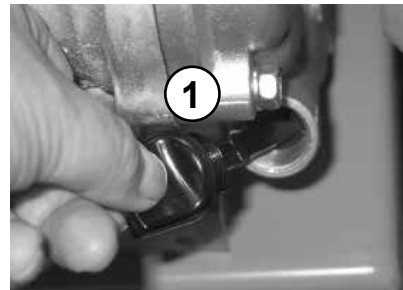

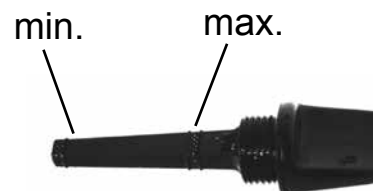

The correct oil level is between the min. and max. marks.



Check the fuel level

Open and remove the gas cap (1), check the level, if necessary top off to the lower edge of the filler neck with clean fuel in accordance with the specification.

-  For work at the fuel system, have a suitable fire-extinguishing agent at the ready.

-  Fire, naked light, and smoking is forbidden!



Water supply

Open water tank (1) and completely fill with clean water.
Close water tank securely with cap (2).

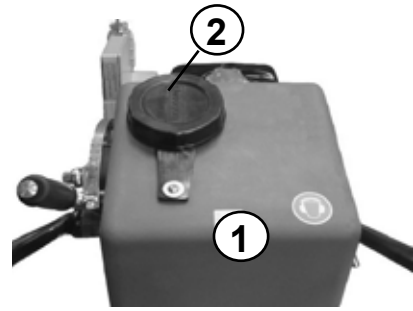

Open the stop cock (1) for sprinkling the water.

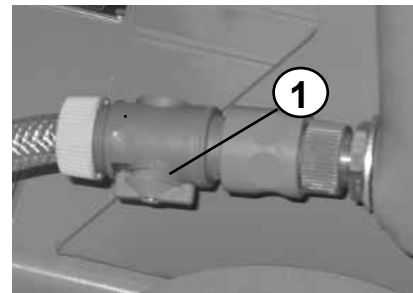

Replacing the cutting disk

Lift the cutting disk protection (1) to the highest position using the cutting depth adjustment lever.



Remove the protective cap (1).

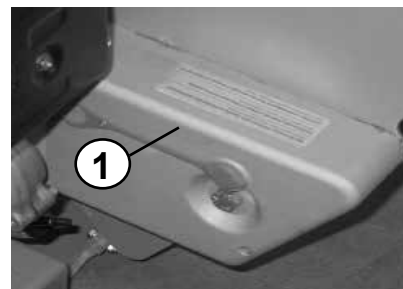

Push 6 mm round steel (1) into the opening (2).
Put the hollow hexagon wrench (2) onto the clamping bolt (1) and rotate the cutting shaft slowly until you feel the 6 mm round steel engage.

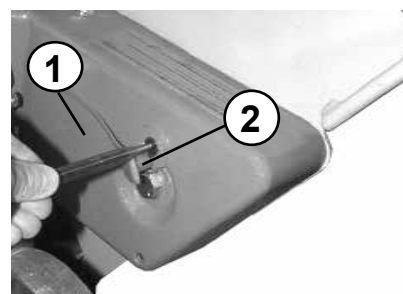

Unscrew the clamping bolt (1).
Clean the holding flange (3) thoroughly.
Install new cutting disk.
Remove the round steel (1) to close the cutting disk protection with the protective cap.

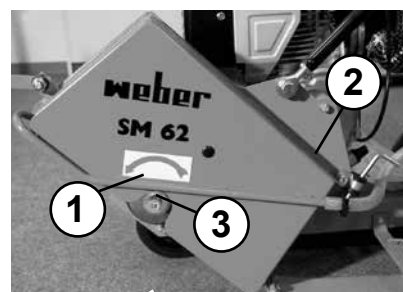

Only use suitable cutting disks.



Installation is performed in the reverse order of removal. The following points have to be observed:



The installation of the cutting disk always has to be carried out in accordance with the direction arrow on the cutting disk, i.e. the arrows on the cutting disk and the cutting disk protection have to point in the same direction.



The cutting disk has to be secured backlash-free on the holding flange and never on the thread.



The support surface of the holding flange and the clamping bolt must be free of notches and any other damage. If this is not the case, then damage can occur and the diamond disk can fail prematurely.



Screw on clamping bolt tightly.



Put hollow hexagon wrench in the holder provided.

Starting

Bring the gas lever (1) into full-throttle position.

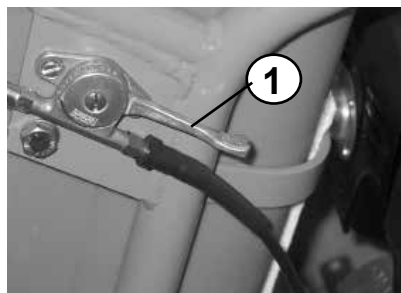

Turn the short-circuit button to the "ON" position.

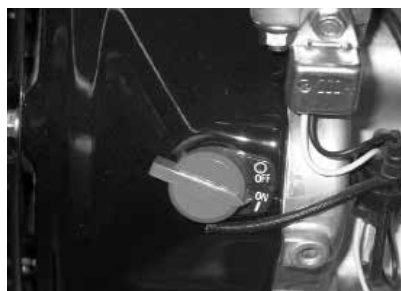

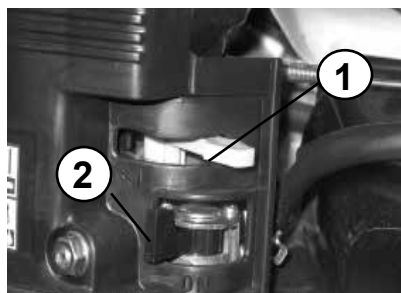

Slide the choke lever (1) to the left (close).

Open the fuel cock (2).

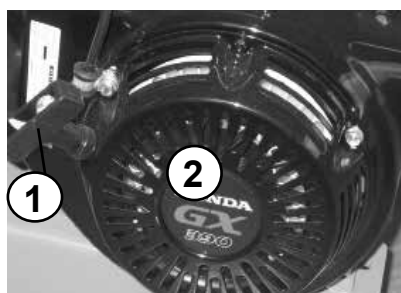

Slowly tighten the handle (1) of the reversing starter (2) until resistance is noticeable.
Allow the handle (1) to glide back into the initial position, and then forcefully and completely pull it through with both hands.



 After the engine has warmed up, slide the choke lever to the right (open).

Cutting

Align the pointer (1) to the marked cut line.

 Enough water should always be supplied for cutting. The water is only supplied to bind with the dust.

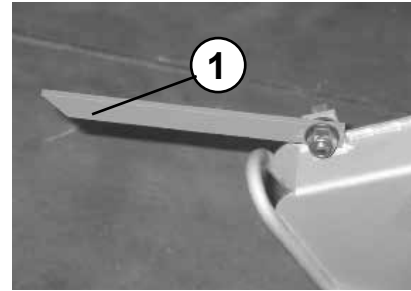

Open the stop cock (1) at the water sprinkling system.

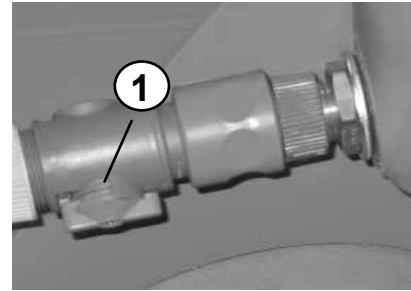



Push the gas lever (1) to full-throttle position.

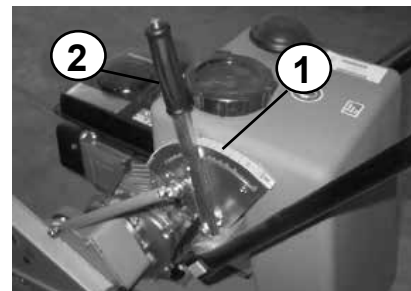

Unlock the cutting depth adjustment lever (1) and set desired cutting depth.

 The scale (1) shows the cutting depth set according to disk diameter.



 Risk of getting cut on the rotating cutting disk.

Shutting down

Bring the gas lever (1) into idle position.

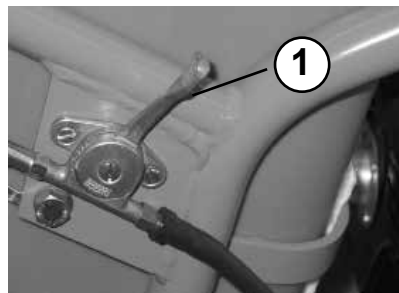

Close the fuel cock (1).

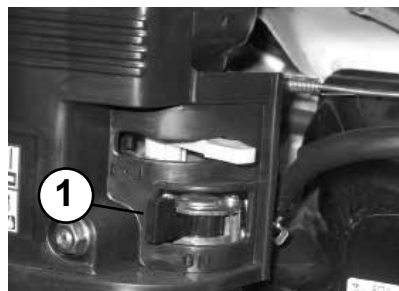

Turn the short-circuit button to the "0" – OFF-position.



Close the water cock (1).

⚠ During breaks – even if they are short – the machine must be shut down.





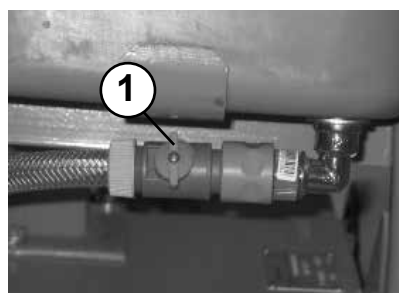

⚠ Parked devices that represent an obstacle must be safeguarded against through conspicuous measures.

⚠ Completely empty the water tank if there might be a frost.



Maintenance overview

Maintenance interval	Maintenance point	Maintenance activity
After the first 25 operating hours	Engine	<ul style="list-style-type: none"> - Changing engine oil - Adjust valve play - Re-tighten all accessible threaded connections
Every 8 operating hours/ daily	Engine	<ul style="list-style-type: none"> - Clean air filter insert, check for damage, replace if necessary - Check the engine oil level
Every 50 operating hours/ every 6 months	Engine Cutting system	<ul style="list-style-type: none"> - Changing engine oil - Check spark plug - Check tension of V-belt
Every 150 operating hours/ every year	Engine Cutting system	<ul style="list-style-type: none"> - Adjust valve play - Replace spark plug - Lubricate the cutting shaft

-  The regulations of the engine manufacturer must be complied with in addition to the above maintenance overview!
-  Work must be carried out using regulation tools, and the operating and maintenance manual must be complied with for all work.
-  All maintenance work: select collection vessels large enough to prevent oil from spilling onto the ground. Dispose of waste oil in an environmentally friendly manner (regulation on waste oils).
-  Dispose of oils, greases, cloths soaked in oil, and replaced parts with oil on them in an environmentally friendly manner.
-  If lubricating oils and fuel come into contact with skin, they can cause skin cancer. Upon contact with the skin, clean affected skin with suitable cleaning agent without delay.
-  If accessible during maintenance, check the condition and stability of all screws.

Maintenance work

Change the engine oil

Remove the oil dip stick (1).

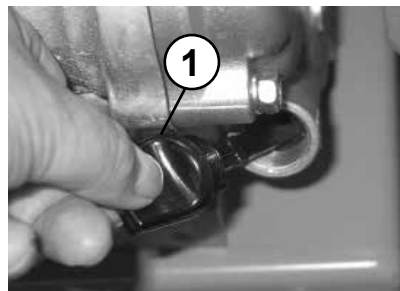

Remove the oil drain screw (1) and drain oil.

 Only drain engine oil when at operating temperature.

After emptying completely, put in the locking screw (1).
Fill with oil in accordance with specifications.

 Danger of scalding due to hot oil.

 When working in the area of the engine compartment there is a danger of being burnt!

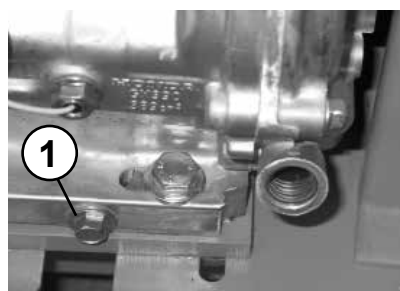

Clean/change air filter cartridge

Remove the air filter cover (1).

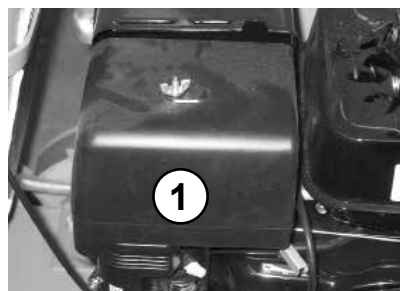

Remove the air filter insert (1) from the air filter enclosure.

Clean air filter insert as specified by the engine manufacturer if there is damage or if it is extremely dirty.

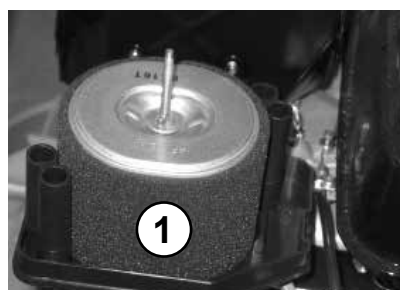

 Dispose of oils, greases, cloths soaked in oil, and replaced parts with oil on them in an environmentally friendly manner.

Changing the spark plug

Pull off the spark plug connector (1).

Screw out spark plug using suitable spark plug wrench.



Only replace spark plug when cold! Risk of injury!

Clean spark plug and check electrode separation, change spark plug if necessary.

Screw in spark plug.



The spark plug has to be tightened well. If it is not tightened properly, it can become very hot and damage the engine.

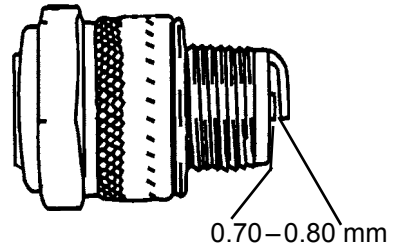
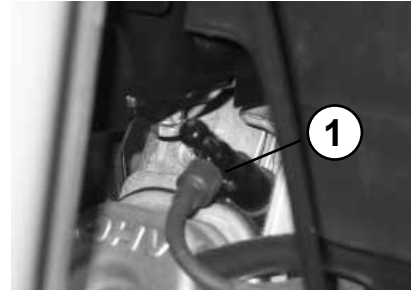

Check ribbed V-belt

Unscrew screw (1) and pivot up rodding (2).

Screw out fastening screws (3).



In order to reach 2 fastening screws, the plastic stoppers (6) have to be removed.



Remove the cutting disk protection (7).



Pull off the water hose (5).

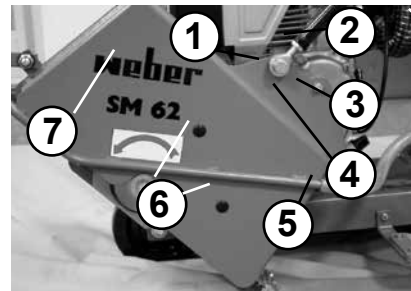

Release fastening screws (2) and screw out fastening screw (3).



Do not completely remove idler pulley (1).

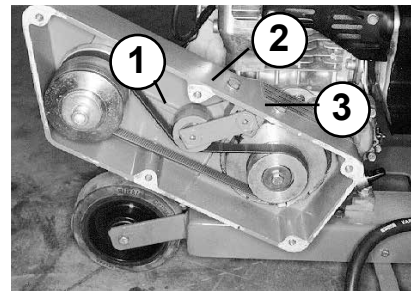

Take ribbed V-belt (1) off the belt pulley (2).

Put on new ribbed V-belt.

Secure idler pulley again.



Ensure the correct seating of the ribbed V-belt on the belt pulley and on the idler pulley.

Reinstall cover of cutting arm together with the cutting disk protection in reverse order.



When putting the cover on the cutting arm, ensure that the water hose is not twisted.

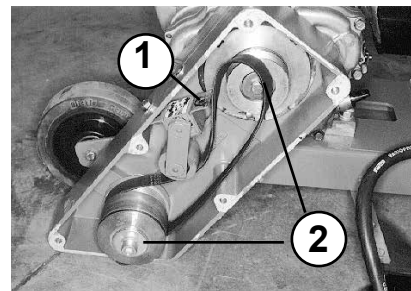

Operating fluids and fill levels

Assembly	Operating material		Quantity SM 62-2
	Summer	Winter	
Engine Engine oil	SAE 10 W 40 (-10 ~ + 50 °C) API - CD CE of SHPD or CCMC - D2 - D3 - PD1		1.1 l
Fuel tank Gasoline	Unleaded gasoline		6.5 l
Water tank			25.0 l
Lubricating points	High-pressure grease (saponified with lithium) in accordance with IDN 51825 - KPF2		As necessary

Troubleshooting

Fault	Possible cause	Remedy
Joint cutter will not start	Operating error	Execute the start process as prescribed
	Lack of fuel	Check the fuel level
	Fuel filter fouled	Clean fuel filter
	Air filter fouled	Clean/change air filter cartridge

Actions to be taken before long-term storage (longer than 1 month)

Entire joint cutter	<ul style="list-style-type: none">– Clean thoroughly– Check for leaks– If there are leaks – correct defects
Fuel tank	<ul style="list-style-type: none">– Empty fuel and fill with clean fuel up to the lower edge of filler neck
Engine	<ul style="list-style-type: none">– Check oil level, if necessary fill to upper oil-level mark– Check air filter, clean, replace if necessary– Check fuel filter, change if necessary
All bare parts / accelerator / accelerator control cable / fastening bolts	<ul style="list-style-type: none">– Oil / grease



If the machine is to be stored for longer than six months, then contact the Weber service organization to discuss additional measures.



facebook.com/WeberMT



youtube.com/MyWeberMT



[Weber Maschinentechnik GmbH](#)

Im Boden 5-8, 10 · 57334 Bad Laasphe · Germany

Phone +49 2754 398 0 · Fax +49 2754 398 101

info@webermt.de · www.webermt.de

085106052-104 / SM 62-2 HD_2020_04_EN
Original instructions