

Operating and Maintenance Manual



SRV 300-II

0170057

Note down the information given on the type plate so that you can recreate the rating plate should the plate be lost.

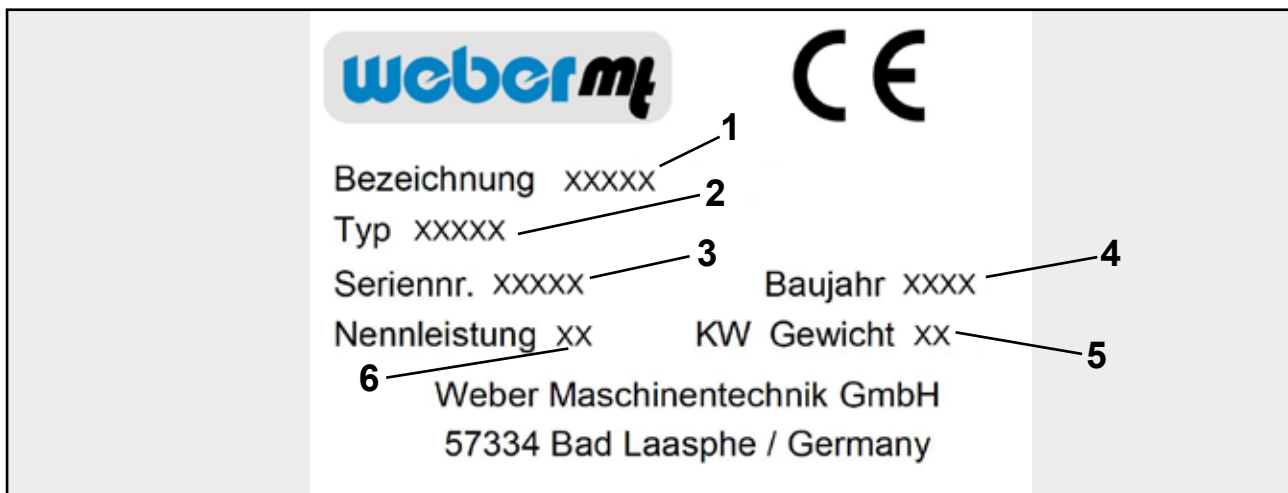

1 Description

.....

2 Type

.....

3 Serial no.

.....

4 Year of construction

.....

5 Weight

.....

6 Rated power kW

.....

Contents

1. Introduction	4
2. Description	5
3. Technical data	6
4. Safety	7
4.1. Information and safety stickers	12
5. Operation	13
6. Transport	18
7. Storage	18
8. Maintenance	19
8.1. Maintenance overview	20
8.2. Description of the maintenance operations	21
8.2.1. Check the engine oil level	21
8.2.2. Change the engine oil	21
8.2.3. Change the fuel filter	22
8.2.4. Clean / change air filter	22
8.2.5. Adjust / replace the spark plug	23
8.2.6. Lubrication	23
8.2.7. Change the tamping foot.....	24
8.3. Operating fluids and fill levels	24

1. Introduction

This operating and maintenance manual is designed to help you become familiar with your soil compactor and enable you to maintain it and use it for its intended purpose.

The safety and maintenance instructions provided in this manual will help avoid hazards, reduce repair and downtime costs and will increase the reliability and operational readiness of your machine. Follow these instructions precisely.

This operating and maintenance manual must always be kept at the implementation site of the machine and be available to the machine operator.

If you require any additional information, turn to your Weber MT dealer.

Found on the last page of this manual is a QR code. Scan it to acquire the current contact addresses of all Weber MT branches.

You can obtain information on the assembled Honda gasoline engine and the associated operating and maintenance manual as well as the spare parts list by logging on to www.honda-engines-eu.com.

You can obtain the current spare parts list of the machine in the WeberMT Service App or use the link below:

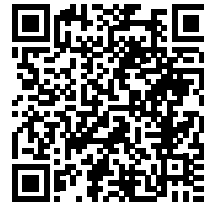

<https://www.webermt.com/DE/deu/ersatzteillistenspare-parts-sre-srv-srx/srv-300/>

2. Description

The machine is a hand-guided vibrating tamper.

An air-cooled Honda gasoline engine makes the tamping system vibrate via a centrifugal clutch.

Start the gasoline engine by hand using the attached reversing starter.

The engine speed is adjusted between idle speed and full-throttle speed via a gas lever.

3. Technical data

	SRV 300
Weight	
Operating weight CECE (in kg)	32
Dimensions	
Overall length (in mm)	585
Overall width (in mm)	315
Height (in mm)	950
Tamping foot width (in mm)	140
Impact rate (/min)	790
Stroke (in mm)	45
Drive	
Engine manufacturer	Honda
Type	GX 50
Performance at operating speed in accordance with ISO 3046-1 (kW)	1.5
Combustion process	4-stroke gasoline
Operating speed (m/min)	6,900
Fuel	Unleaded gasoline

	SRV 300
Noise emissions in accordance with 2000/14/EC	
Sound pressure level L_{PA} ascertained in accordance with EN 500, in dB (A)	98
Sound pressure level L_{WA} ascertained in accordance with EN ISO 3744 and EN 500, in dB (A)	108
Vibration values	
Root-mean-square acceleration value for hand-arm vibration ascertained in accordance with EN 500 in m/s^2	7.4
In accordance with directive 2006/42/EC, complying with the vibration values is the owner's responsibility.	

4. Safety

General

All safety instructions must be read and complied with, as non-compliance will result in

- Danger to life and limb of the user,
- Impairments to the machine or other property.

In addition to the operating manual, the accident-prevention regulations in the country where the appliance is used must be complied with.

Intended use

The machine should only be used in technically faultless condition, as intended, in a safety-conscious and hazard-conscious manner, and in compliance with the instructions in the operating manual.

Malfunctions that may impair safety require that you stop working with the machine immediately. These types of damage must be reported and corrected without delay.

The machine is designed exclusively for compacting:

- Sand,
- Gravel,
- Crushed rock,
- Semi-cohesive mixed material.

The operator's work position is behind the machine. The operator must guide the machine safely with both hands on the handle.

Non-intended use

Unless used as intended, the machine involves a risk of personal injury and property damage. The machine is expressly not suitable for:

- compacting frozen subsurfaces,
- compacting hard soils that cannot be compacted further,
- compacting non-bearing material,
- compacting highly cohesive soils,
- compacting (ramming) that exerts point loads on the base plate,
- crushing and compacting individual rocks.

The responsibility for any damage arising from non-intended use falls on the owner / operator rather than the manufacturer. Damage that can be attributed to non-intended use of the machine will void any warranty claims.

Residual risk

There is always an increased risk of accidents in the immediate danger area around the machine if the operator fails to notice persons in the vicinity of the machine. Make anyone close to the machine aware of this risk. The operator must not put the machine into operation unless everyone in the vicinity of the machine is aware of this risk.

Requirements on the operator	<p>This soil compactor may only be operated by suitable operators who are 18 years or older. They must be instructed on how to operate the machine by the owner or by the owner's assigned personnel. The operator must comply with traffic regulations.</p> <p>The machine must not be operated by children.</p>
Personal protective equipment	<p>Personal protective equipment must be worn during operation and while performing maintenance on the machine. It consists of:</p> <ul style="list-style-type: none"> - protective goggles, - hearing protection, - work shoes or boots with toe guard.
Danger areas	<p>The immediate danger area is the direct perimeter around the machine. This area is off-limits to third parties.</p>
Spare parts, changes and conversions	<p>Changes and conversions are prohibited unless made with original Weber MT spare parts. If the machine is modified with other accessories without the approval of Weber MT, the manufacturer will not assume liability for any resulting personal injury or property damage.</p> <p>All maintenance and repairs must be carried out with original Weber MT spare parts. Untested spare parts may affect the reliability and safety of the machine.</p>
Before starting the machine	<p>After horizontal transport, the oil may have spread inside the engine. To prevent damage to the engine, the machine must be brought to the vertical position for several minutes until the oil has collected in the lower area of the crankcase.</p> <p>There is danger of material damage if the machine is started before necessary maintenance or repairs have been completed. Make sure every time before starting the machine that all work on the machine has been completed.</p> <p>To avoid injuries, the machine must not be started unless the operator wears the required personal protective equipment.</p> <p>Objects placed on top of the machine may fall or be flung off during operation or when the machine is started. Therefore, remove all loose objects or tools before starting the machine.</p> <p>If the gas cap is open, fuel may escape and ignite on the engine when the machine is started or while it is operating. There is a risk of burns. Therefore, do not start the machine unless the gas cap is closed.</p>

Start-up procedure

Do not disperse any sprays or other agents into the air intake while the machine is starting up. They may lead to overheating in the combustion chamber and result in damage to the engine.

There is danger of suffocation if the operator starts up the machine in closed rooms or in deep and tight trenches. Operating the machine in closed rooms is prohibited. Provide for an adequate supply of air before starting the machine.

During operation

There is a crushing hazard under the tamping foot during operation.

The personal protective equipment will protect the toes, but not the entire foot. Do not step under the tamping foot.

Monitor the surroundings to avoid injury to third parties or material damage.

Suspend operation and shut down the machine if detecting damage on the machine during operation.

Parking the machine

Always park the machine on a level subsurface with sufficient bearing capacity.

Parked machines presenting an obstacle must be secured in accordance with statutory regulations, particularly in the area of public traffic surfaces.

Engine and exhaust heat up during operation and can cause burns on contact. Therefore, do not touch these components during operation or shortly after the engine was switched off.

Fueling the machine

Spilled fuel may ignite and has a negative impact on the environment. Therefore, wipe up spilled fuel and make sure the gas cap is firmly tightened after fueling.

Fuel vapors are easily flammable. Do not smoke and keep away from open fire while refueling the machine. The machine must not be fueled unless the engine is switched off.

When coming into contact with fuels, the rubber-bonded metal buffers of the machine may become damaged or ineffective. Therefore, wipe spilled fuel carefully off the rubber-bonded metal buffers.

Cleaning work

Use clear water for cleaning. Do not use flammable solvents. The vapors of the solvents may ignite upon contact with hot components or other sparks.

Perform cleaning tasks only in rooms that are suitable and have been approved for that purpose. Residual oil and lubricants that may have been rinsed off have a negative impact on the environment and must be collected by suitable means (e.g. oil separator).

Safe handling of combustion engines





Combustion engines pose a particular risk during operation. Their exhaust emissions contain carbon monoxide, a colorless and odorless gas that is extremely hazardous, which, if inhaled even briefly, can cause unconsciousness and death. Therefore, never inhale the exhaust gas.

Inspection

The machine must be inspected in accordance with the corresponding implementation conditions and operating conditions to ensure its operationally safe status. This inspection should be performed as needed by an expert - however, no less than once a year. The findings of the inspection must be stored in writing until the time of the next inspection.

Safety instructions and warnings



A variety of safety instructions and warnings are used throughout this operating manual. The following explains the meaning of signal words and symbols.

	ATTENTION warns of the danger of material damage.
	CAUTION warns of the danger of slight injury.
	WARNING warns of a danger that may lead to death or serious injury.
	DANGER warns of a danger that will lead to death or serious injury unless avoided.

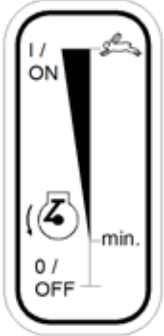

The information symbol provides supplemental information on the operation of the machine and points to complementary technical information.

4.1. Information and safety stickers

	Sticker	Meaning
1	 <p>The sticker consists of two parts. The top part is a blue circle containing a white icon of a person wearing headphones, representing hearing protection. The bottom part is a white rectangle with a black border. It features a small icon of a speaker on the left, followed by the text 'L_{WA}' and '108dB' in large, bold black font.</p>	<p>The sound power level is 108 dB (A). Therefore, wear suitable hearing protection at all times.</p>
2	 <p>The sticker is a vertical rectangle with rounded corners. It shows a gas lever with a vertical scale. At the top, it says '1 / ON' with a small icon of a lever. At the bottom, it says '0 / OFF' with a small icon of a lever. A 'min.' label is positioned near the bottom of the scale.</p>	<p>Positions of the gas lever.</p>
3	 <p>The sticker is a vertical rectangle with rounded corners. It contains a white icon of a lifting ring with an upward-pointing arrow above it, all within a white border.</p>	<p>Use the designated lifting ring to lift the machine.</p>
5	 <p>A yellow rectangular sticker with rounded corners and a black border. It contains the text 'Normalbenzin', 'Gasoline', and 'Essence' stacked vertically in black font.</p>	<p>The fuel tank may only be fueled with regular gasoline.</p>

5. Operation

Preparing the machine for initial use

- ▶ Remove all packaging material.
- ▶ Check all components for visible damage. Do not start the machine if detecting visible damage. Contact the responsible dealer.
- ▶ Check if the shipment of the machine and its components is complete.
- ▶ Check the fill level of the operating fluids and top off if necessary.
- ▶ Set up the machine at its place of use.

Operating positions on the machine

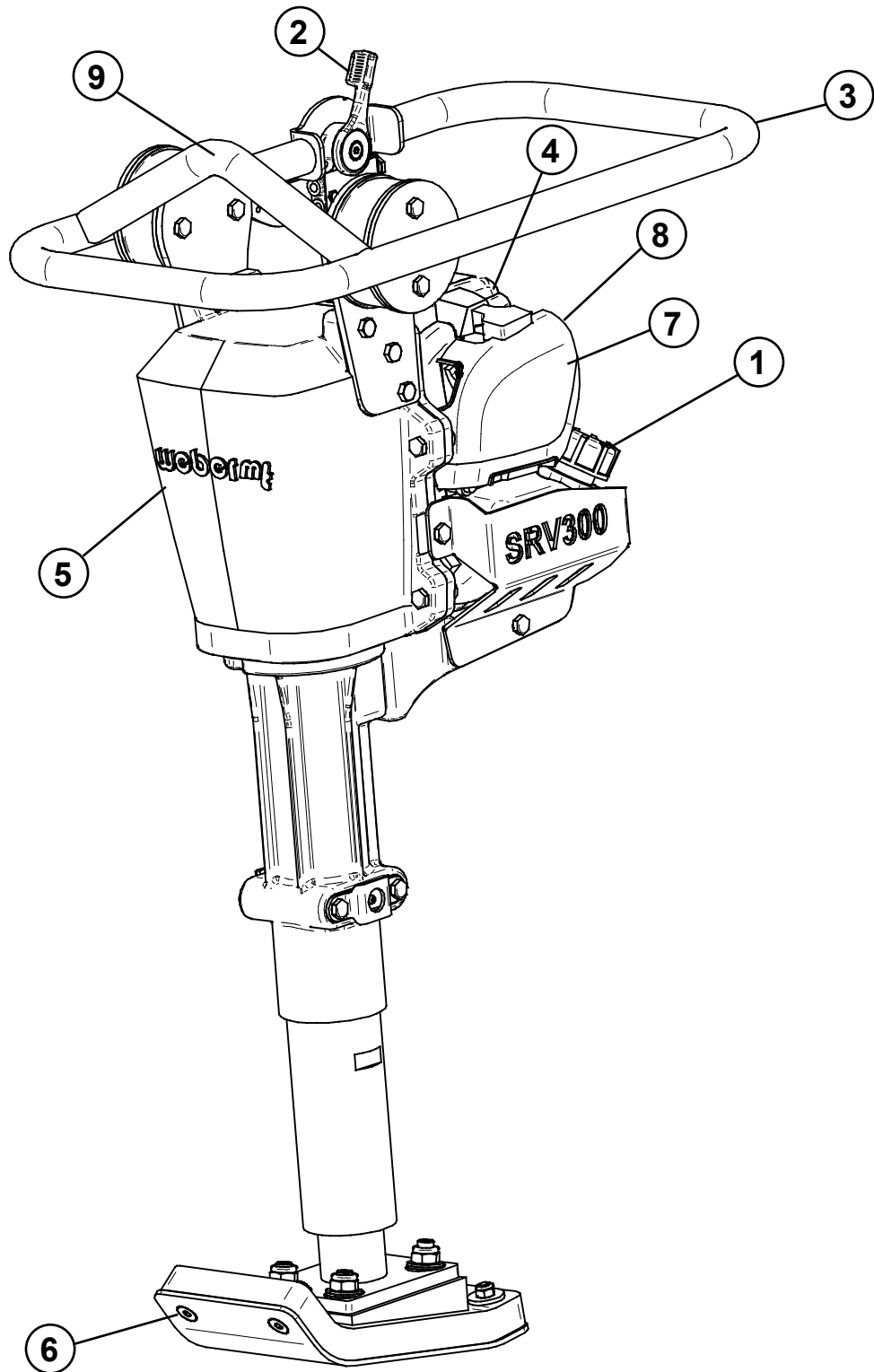

Overall view SRV

- | | | | |
|---|---------------------|---|---------------|
| 1 | Fuel tank | 6 | Tamping foot |
| 2 | Gas lever | 7 | Air filter |
| 3 | Manual guidance rod | 8 | Choke lever |
| 4 | Engine | 9 | Crane bracket |
| 5 | Tamping system | | |

Before starting work

Perform the following tasks before starting to work in order to prevent failures or excessive wear.

Visual inspections

- ▶ Entire machine for external damage.
- ▶ Fuel system for leaks.
- ▶ Rubber buffers for crack formation.

Check and, if necessary, correct the fill levels

- ▶ Engine oil level
- ▶ Fuel level

Other inspections

- ▶ Compliance with the maintenance schedule
- ▶ Threaded unions for firm seat

Working with the machine

Starting the engine

⚠ WARNING

Danger of suffocation from engine exhausts when starting the engine in closed rooms or poorly ventilated work areas.

- ▶ Start the engine only in well-ventilated environments.
- ▶ See section “Safety” for operating the machine in trenches.

ATTENTION

Risk of engine damage caused by insufficient lubrication after horizontal transport.

- ▶ Following horizontal transport, set up the machine vertically and wait several minutes until the engine oil has collected in the lower area of the crankcase.
- ▶ Start the engine as described.

ATTENTION

Risk of engine damage. The use of starter spray may lead to overheating in the combustion chamber.

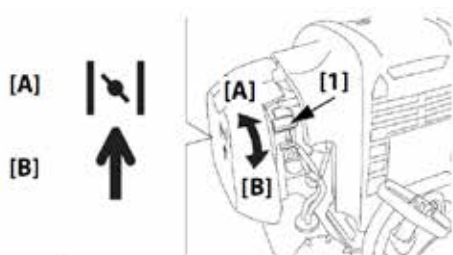

- ▶ Do not use any starter spray.
- ▶ Bring the gas lever into the full-throttle position (I / ON).
- ▶ Close the choke lever (1) (position A).
- ▶ Press the primer pump (2) multiple times until the fuel feed pipe is filled with gasoline.
- ▶ Slowly pull the handle of the reversing starter until resistance (the compression of the engine) is noticeable.
- ▶ Allow the handle to glide back into the initial position.

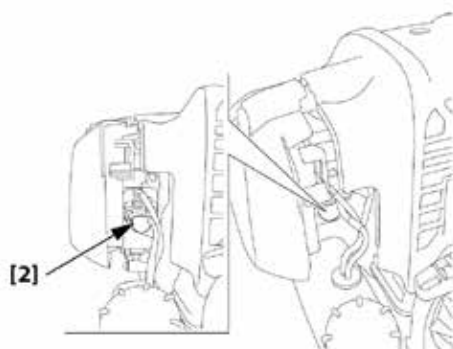

- ▶ **⚠ CAUTION!** The tamper may tip over when the reversing starter is pulled. There is a crushing hazard.
- ▶ Hold on firmly to the tamper while starting it.
- ▶ Pull the handle through quickly, forcefully and completely.
- ▶ Repeat the process if the engine does not start.

⚠ CAUTION! As soon as it starts running, the engine will increase the speed. There is a risk of injury as the tamper is started at full throttle and may perform unexpected movements.

- ▶ Set the gas lever to idle speed immediately after the engine has started to run.
- ▶ Allow the engine to warm up for a few minutes. Next, open the choke lever (position B).

Compacting

WARNING

There is a crushing hazard under the tamping foot from the movement of the tamper during compacting.

- ▶ Wear the personal protective equipment.
- ▶ Only guide the tamper in the grip area of the manual guidance rod.

CAUTION

There is a crushing hazard between the tamper and the wall during work in close proximity to walls.

- ▶ Use extra caution when working close to obstacles.

CAUTION

If guided incorrectly, the tamper may tip over during operation. There is a crushing hazard.

- ▶ Guide the tamper safely with both hands in the grip area of the manual guidance rod.

ATTENTION

Risk of material damage if the machine is guided improperly. Pulling the machine back against its actual direction of travel will overload, and possibly break, the guided cylinder.

- ▶ Never pull the tamper back against its actual direction of travel.
- ▶ Start the engine.
- ▶ Bring the gas lever into the full-throttle position.
- ▶ Guide the tamper with both hands on the manual guidance rod.

Switching off the engine

- ▶ Allow the engine to cool down at idle speed for a few minutes ("min" position).
- ▶ To switch the machine off, set the gas lever to the "0 / OFF" position.
- ✓ The engine is switched off.

6. Transport

Lifting the machine

The machine can be lifted for loading onto a vehicle.

CAUTION

Risk of material damage and injuries. The use of defective or unsuitable lifting gear may cause the machine to fall down.

- ▶ Use slings that possess the appropriate carrying capacity.
- ▶ Fit the crane hook into the lifting ring and lift the machine up straight.

Storage during transport

Preferably transport the tamper in the upright position. If this is not possible, the tamper must be laid on the side that houses the exhaust. This is the only way to prevent any remaining fuel from exiting the carburetor and fuel line and entering the air filter.

7. Storage

Storage at the construction site

If stored at the construction site, e.g. over night, the machine must be secured against theft and unauthorized use.

Parked machines presenting an obstacle must be secured in accordance with statutory regulations, particularly in the area of public traffic surfaces.

Storage for an extended period

If the machine will not be used for a period longer than one month, the following measures must be taken:

- ▶ Clean the entire machine thoroughly.
- ▶ Check the entire machine for leaks. Correct any detected defects.
- ▶ Empty fuel and fill the tank with clean fuel.
- ▶ Check and, if necessary, correct the engine oil level.
- ▶ Check and clean air and fuel filter. Replace if damaged.
- ▶ Lightly oil all bare parts, levers and accelerator control cables.



If the machine is to be stored for longer than six months, contact the Weber MT's service organization to discuss additional measures.

8. Maintenance

General information

The section below contains instructions that need to be observed for regular maintenance. Read these instructions carefully and follow them in order to prevent downtimes of the machine caused by excessive wear or damage to the machine. Also read the safety instructions relevant to machine maintenance before you begin with the maintenance work. They help minimize the risk to maintenance personnel.

Maintenance personnel

Maintenance and repairs require specific qualifications. These operations may only be carried out by trained professionals. Maintenance personnel must be instructed on how to operate the machine by the owner or by the owner's assigned personnel.

Maintenance personnel are required to wear the personal protective equipment during work (see section "Safety").

Safety

There is an increased risk of injury during maintenance and repairs, e.g. crushing at moving parts.

Following the conclusion of all maintenance and repairs, all protective fixtures must be refitted and placed back into operation.

Discharged operating fluids have a negative impact on the environment. They must be collected and stored in suitable containers. Disposal in accordance with environmental protection regulations.

All maintenance work may only be carried out when the engine is switched off. Safeguard the engine against unauthorized start attempts.

Before starting the machine after maintenance operations, make sure that all loose parts (screws, tool, etc.) have been removed from the machine. They can be drawn in or flung off by moving parts.

Keep the entire machine clean. The stickers must always be clearly legible. Damaged stickers must be replaced.

8.1. Maintenance overview

Activity	Frequency			See section
	Initial maintenance / after 10 operating hours	Every 50 operating hours / every six months	Every 150 operating hours / every year	
Change the engine oil	X	X	X	8.2.2
Re-tighten all accessible threaded connections	X			
Check the valve of the engine			X	Honda instructions
Replace the fuel filter		X	X	8.2.3
Clean the air filter, check for damage and replace if necessary		X	X	8.2.4
Apply grease to the lubricating points		X	X	8.2.6



The regulations and the operating and maintenance manuals of the engine manufacturer must be complied with in addition to the activities specified in the above maintenance overview.



YouTube Playlist - Service Videos

8.2. Description of the maintenance operations

8.2.1. Check the engine oil level

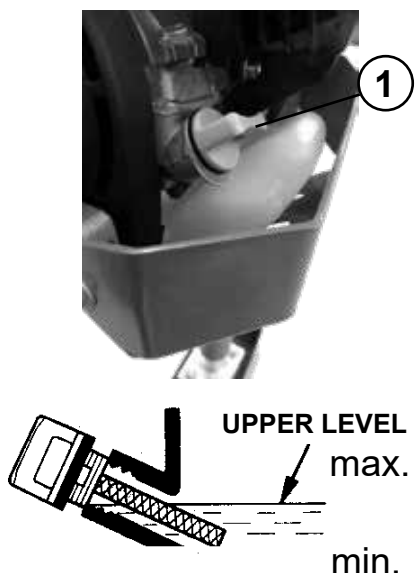

⚠ WARNING

If lubricating oils and fuel come into contact with skin, they can cause skin cancer.

- ▶ Wear protective gloves.
- ▶ If skin contact has occurred, wash the affected areas thoroughly.
- ▶ Park the machine on a horizontal subsurface.
- ▶ Switch off the engine and wait for several minutes until the oil has collected in the crankcase.
- ▶ Unscrew the oil dip stick from the crankcase.
- ▶ Wipe off the oil dip stick with a clean cloth.
- ▶ Insert the oil dip stick in the oil filler neck as shown, but do not screw it in.
- ▶ Pull out and read the oil dip stick; the correct oil level ranges between the upper level (max) and the lower level (min).
- ▶ Screw the oil dip stick back into the oil filler neck.

8.2.2. Change the engine oil

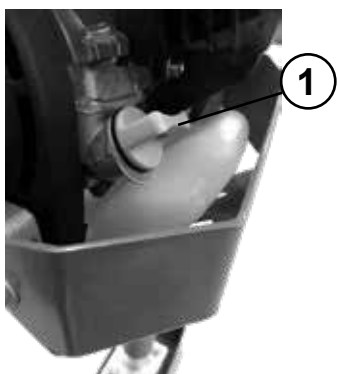

⚠ CAUTION

Danger of burn injuries at the hot engine and its attachments.

- ▶ Allow the combustion engine to cool down sufficiently before starting work.
- ▶ Use extra caution during work on the engine when it is at operating temperature.
- ▶ Start the engine and allow the engine to warm up for a few minutes.
- ▶ Switch off the engine.
- ▶ Unscrew the oil dip stick (1).
- ▶ Place a suitable collection vessel under the opening.
- ▶ Tip the machine to the side and allow the oil to drain through the opening.
- ▶ Stand the machine up.
- ▶ Fill in fresh oil that complies with the specification until you reach the upper mark (max.).
- ▶ Screw in the oil dip stick.

8.2.3. Change the fuel filter

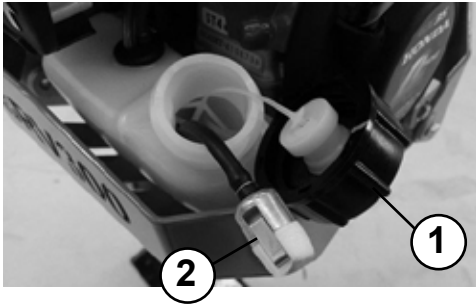

- ▶ Open the gas cap (1).
- ▶ Pull the fuel filter (2) out of the tank.
- ▶ Pull the fuel filter off the fuel line
- ▶ Insert a new fuel filter.
- ▶ Close the gas cap.

8.2.4. Clean / change air filter

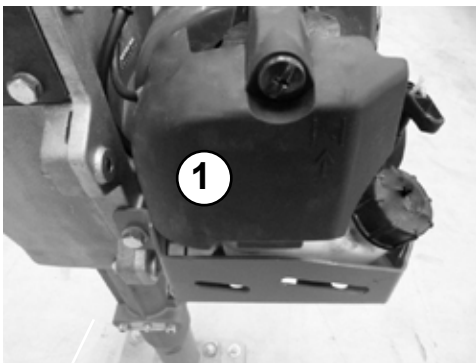

- ▶ Unscrew and take off the air filter cover (1).
- ▶ Remove the air filter insert (2).
- ▶ Clean the air filter insert by tapping it carefully against a hard surface.
- ▶ Blow out the air filter insert from inside to outside with compressed air.
- ▶ Replace the air filter insert and the air filter fleece if there is damage or extreme contamination.
- ▶ Insert the air filter insert and the air filter fleece into the enclosure.
- ▶ Place the air filter cover back onto the enclosure and screw it in place.

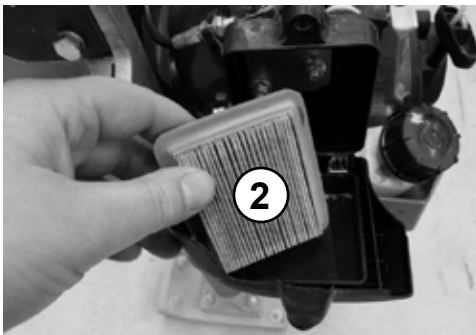

8.2.5. Adjust / replace the spark plug

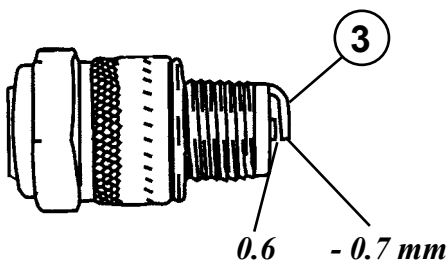
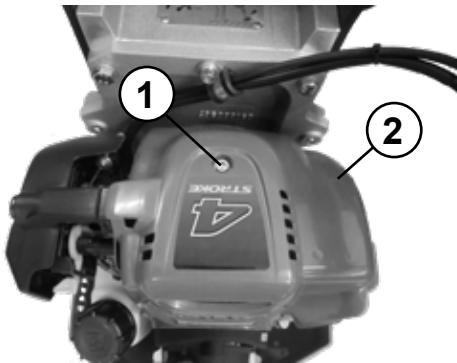

CAUTION

Danger of burn injuries at the hot engine and its attachments.

- ▶ Allow the combustion engine to cool down sufficiently before starting work.
- ▶ Use extra caution during work on the engine when it is at operating temperature.

- ▶ Unscrew the screw (1) on the protective cap (2).
- ▶ Remove the protective cap.
- ▶ Pull off the spark plug connector.
- ▶ Unscrew the spark plug.
- ▶ Clean the electrode (3) of the spark plug.
- ▶ Measure the electrode air gap; it must be 0.6-0.7 mm.
- ▶ If necessary, correct the electrode air gap or replace the spark plug.
- ▶ Install the protective cap and tighten the screw.

8.2.6. Lubrication

There are three lubricating points on the SRV 300 tamper. They are easy to access and require no prior disassembly. Apply grease as follows every 50 operating hours or every six months:



- ▶ Lubricating points "anti-rotation locking device" (right and left)
- ▶ 1-2 strokes, KP2K-20 grease.



- ▶ Lubricating point "crankcase"
- ▶ 4-5 strokes, KP2K-20 grease.

8.2.7. Change the tamping foot



- ▶ Loosen the 4 nuts (1) of the tamping foot (2).
- ▶ Lift the tamper off the tamping foot (2).
- ▶ Install a new tamping foot.
- ▶ The tightening torque of the nuts (1) is 35 Nm.

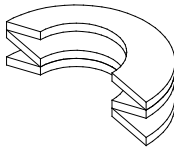

Mounting arrangement of the plate springs

- ▶ Arrange the plate springs below the nuts as shown in the adjacent illustration.

8.3. Operating fluids and fill levels

	Operating material		Quantity
	Summer	Winter	
Engine oil	SAE 10 W 40		0.13 L
Gasoline	Unleaded gasoline in accordance with DIN 51607		0.63 L
Lubricating points	Shell Gadus S2 V 220AD 2 or comparable KP2K-20 grease		As necessary



facebook.com/WeberMT



youtube.com/MyWeberMT



Weber Maschinenteknik GmbH

Im Boden 5-8, 10 · 57334 Bad Laasphe · Germany
Phone +49 2754 398 0 · Fax +49 2754 398 101
info@webermt.de · www.webermt.de

085102453-104 / SRV300-II_2022-09
Original instructions