

Operating and Maintenance Manual

webermf



CR 6

CR 6 MDM

CR 6 CCD 2.0

0116521; 0116530;

0116531; 0116533;

0116534

Attached to the machine is a rating plate. Note down the information given on this plate so that you can recreate the rating plate should the plate be lost.

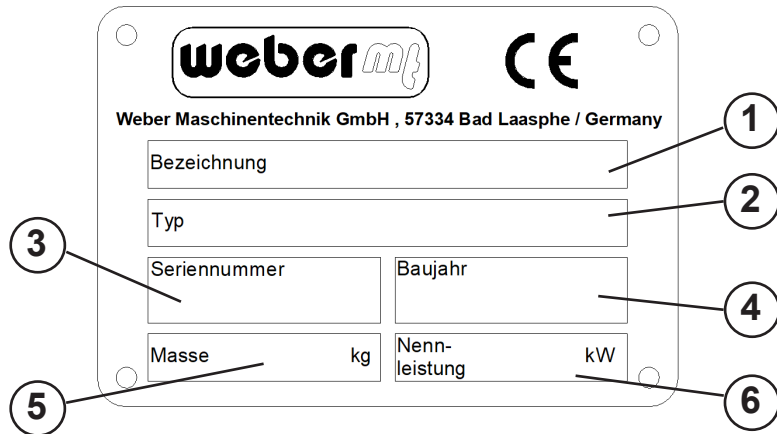

1 Designation

.....

2 Type

.....

3 Serial no.

.....

4 Year of construction

.....

5 Weight

.....

6 Rated power kW

.....

Contents

- 1. Introduction..... 4**
- 2. Description..... 5**
- 3. Technical data..... 6**
- 4. Safety..... 7**
 - 4.1. Information and safety stickers 12
- 5. Operation..... 13**
- 6. Transport..... 23**
- 7. Storage 23**
- 8. Maintenance..... 24**
 - 8.1. Maintenance overview 25**
 - 8.2. Description of the maintenance operations..... 26**
 - 8.2.1. Clean the air filter 26
 - 8.2.2. Check V-belt..... 26
 - 8.2.3. Check the engine oil level 27
 - 8.2.4. Change the engine oil 27
 - 8.2.5. Clean the engine oil filter 28
 - 8.2.6. Check the water separator 29
 - 8.2.7. Change the fuel filter 29
 - 8.2.8. Check the hydraulic oil level 29
 - 8.2.9. Change the oil in the exciter 30
 - 8.2.10. Change the fuses..... 30
 - 8.2.11. Use a permanent charger 30
 - 8.3. Operating fluids and fill levels 31**

1. Introduction

This operating and maintenance manual is designed to help you become familiar with your soil compactor and enable you to maintain it and use it for its intended purpose.

The safety and maintenance instructions provided in this manual will help avoid hazards, reduce repair and downtime costs and will increase the reliability and operational readiness of your machine. Follow these instructions precisely.

This operating and maintenance manual must always be kept at the implementation site of the machine and be available to the machine operator.

Enclosed with this manual is a valid declaration of conformity and a spare parts lists for orders of spare parts. Store these documents carefully.

If you require any additional information, turn to your Weber MT dealer.

Found on the last page of this manual is a QR code. Scan it to acquire the current contact addresses of all Weber MT branches.

You can obtain information on the assembled Hatz diesel engine and the associated operating and maintenance manual as well as the spare parts list, if needed, at www.hatz-diesel.com

2. Description

The machine

The machine is a hand-guided, reversible soil compactor. The machine is composed of a bottom and a top section. The bottom section houses the exciter, while the top section contains the engine and the required controls.

An air-cooled Hatz diesel engine makes the exciter vibrate via a centrifugal clutch. The generated force is transmitted between top and bottom section via a V-belt. The engine is started electronically by a permanently installed start module.

The engine speed is adjusted between idle speed and full-throttle speed via a gas lever. Forward and reverse travel is variably controlled with a handle via a hydraulic system.

3. Technical data

	CR 6	CR 6 MDM	CR 6 CCD 2.0
Weight			
Operating weight CECE [kg]	412	414	414
Dimensions			
Overall length [mm]	1710	1710	1710
Overall width/with attachment plates [mm]	450/590/740	450/590/740	450/590/740
Height with folded guide bar [mm]	1160	1160	1160
Base plate length [base in mm]	450	450	450
Pressure surface [mm]	450x590/450x740	450x590/450x740	450x590/450x740
Drive			
Engine manufacturer	Hatz	Hatz	Hatz
Type	1 B 40	1 B 40	1 B 40
Performance at operating speed in accordance with ISO 3046-1 [kW]	5.8	5.8	5.8
Combustion process	4-stroke diesel	4-stroke diesel	4-stroke diesel
Operating speed [1/min]	2750	2750	2750
Operating speed [soil-dependent, m/min]	24	24	24
Incline capacity [soil-dependent, %]	35	35	35
Vibration			
System	Two-shaft vibrator	Two-shaft vibrator	Two-shaft vibrator
Drive concept	mechanical	mechanical	mechanical
Frequency [Hz]	72	72	72
Centrifugal force [kN]	55	55	55
Noise emissions in accordance with 2000/14/EC			
Sound pressure level LPA ascertained in accordance with EN 500, [dB (A)]	94	94	94
Sound power level LWA ascertained in accordance with EN ISO 3744 and EN 500, [dB (A)]	108	108	108
Vibration values			
Root-mean-square acceleration value for hand-arm vibration ascertained in accordance with EN 500, [m/s ²] In accordance with directive 2006/24/EC, complying with the vibration values is the owner's responsibility	2.4	2.4	2.4

4. Safety

General

All safety instructions must be read and complied with, as non-compliance will result in

- Danger to life and limb of the user,
- Impairments to the machine or other property.

In addition to the operating manual, the accident-prevention regulations in the country where the appliance is used must be complied with.

Intended use

The machine should only be used in technically faultless condition, as intended, in a safety-conscious and hazard-conscious manner, and in compliance with the instructions in the operating manual.

Malfunctions that may impair safety require that you stop working with the machine immediately. These types of damage must be reported and corrected without delay.

The machine is designed exclusively for compacting:

- Sand,
- Gravel,
- Crushed rock,
- Low-cohesive mixed material,
- Paved surfaces.

The operator's work position is behind the machine.

The operator must guide the machine safely with both hands on the handle.

Non-intended use

Unless used as intended, the machine involves a risk of personal injury and property damage. The machine is expressly not suitable for:

- Compacting frozen subsurfaces,
- Compacting hard soils that cannot be compacted further,
- Compacting non-bearing material,
- Compacting highly cohesive soils,
- Compacting (ramming) that exerts point loads on the base plate,
- Crushing and compacting individual rocks.

The responsibility for any damage arising from non-intended use falls on the owner / operator.

Non-intended use or misuse will void all liability and warranty claims.

Residual risk

There is always an increased risk of accidents in the immediate danger area around the machine if the operator fails to notice persons in the vicinity of the machine.

Anyone close to the machine must be made aware of this risk. The operator must not put the machine into operation unless everyone in the vicinity of the machine is aware of this risk.

Requirements on the operator	<p>This soil compactor may only be operated by suitable operators who are 18 years or older. They must be instructed on how to operate the machine by the owner or by the owner's assigned personnel. The operator must comply with traffic regulations.</p> <p>The machine must not be operated by children.</p>
Personal protective equipment	<p>Personal protective equipment consisting of</p> <ul style="list-style-type: none"> - Hard hat, - Hearing protection, - Protective gloves, - Work shoes or boots with toe guard <p>must be worn during operation and the execution of maintenance on the machine.</p>
Danger areas	<p>The immediate danger area is the direct perimeter around the machine. This area is off-limits to third parties.</p>
Spare parts, changes and conversions	<p>Changes and conversions are prohibited unless made with original Weber MT spare parts. If the machine is modified with other accessories without the approval of Weber MT, the manufacturer will not assume liability for any resulting personal injury or property damage.</p> <p>All maintenance and repairs must be carried out with original Weber MT spare parts. Untested spare parts may affect the reliability and safety of the machine.</p>
Before starting the machine	<p>There is danger of material damage if the machine is started before necessary maintenance or repairs have been completed. Make sure every time before starting the machine that all work on the machine has been completed.</p> <p>To avoid injuries, the machine must not be started unless the operator wears the required personal protective equipment.</p> <p>Objects placed on top of the machine may fall or be flung off during operation or when the machine is started. Therefore, remove all loose objects or tools before starting the machine.</p> <p>If the gas cap is open, fuel may escape and ignite on the engine when the machine is started or while it is operating. There is a risk of burns. Therefore, do not start the machine unless the gas cap is closed.</p>

Start-up procedure

Do not disperse any sprays or other agents into the air intake while the machine is starting up. They may lead to overheating in the combustion chamber and result in damage to the engine.

There is danger of suffocation if the operator starts up the machine in closed rooms or in deep and tight trenches. Operating the machine in closed rooms is prohibited. Provide for an adequate supply of air before starting the machine.

One start procedure must not last longer than 30 seconds to avoid damage to the engine. If the engine fails to turn over after no more than 30 seconds, turn the ignition key back to the "0" position and eliminate the cause.

If the ignition key fails to spring back to position "1" by itself, the electric starter and the engine may sustain damage. Abort the start procedure and shut down the machine. Identify and rectify the cause before the next start attempt.

During operation

Monitor the surroundings to avoid injury to third parties or material damage.

Suspend operation and shut down the machine if detecting damage on the machine during operation.

Stop operation and shut down the machine if the light indicators of the start module do not go out shortly after startup or come on during operation.

The symbol ☺ is lit permanently during operation. It signals that the engine is running. Refer to the section "Operation" for the exact meaning of the individual light indicators.

Parking the machine

Always park the machine on a level subsurface with sufficient bearing capacity.

Parked machines presenting an obstacle must be secured in accordance with statutory regulations, particularly in the area of public traffic surfaces.

Engine and exhaust heat up during operation and can cause burns on contact. Therefore, do not touch these components during operation or shortly after the machine was switched off.

Fueling the machine

Spilled fuel may ignite and has a negative impact on the environment. Therefore, wipe up spilled fuel and make sure the gas cap is firmly tightened after fueling.

When coming into contact with fuels, the rubber-bonded metal buffers of the machine may become damaged or ineffective. Therefore, wipe spilled fuel carefully off the rubber-bonded metal buffers.

Fuel vapors are easily flammable. Do not smoke and keep away from open fire while refueling the machine. The machine must not be fueled unless the engine is switched off.

Cleaning work

Use clear water for cleaning. Do not use flammable solvents. The vapors of the solvents may ignite upon contact with hot components or other sparks.

Perform cleaning tasks only in rooms that are suitable and have been approved for that purpose. Residual oil and lubricants that may have been rinsed off have a negative impact on the environment and must be collected by suitable means (e.g. oil separator).

Safe handling of combustion engines





Combustion engines pose a particular risk during operation. Their exhaust emissions contain carbon monoxide, a colorless and odorless gas that is extremely hazardous, which, if inhaled even briefly, can cause unconsciousness and death. Therefore, never inhale the exhaust gas.

Inspection

The machine must be inspected in accordance with the corresponding implementation conditions and operating conditions to ensure its operationally safe status. This inspection should be performed as needed by an expert - however, no less than once a year. The findings of the inspection must be stored in writing until the time of the next inspection.

Safety instructions and warnings

A variety of safety instructions and warnings are used throughout this operating manual. The following explains the meaning of signal words and symbols.

	ATTENTION warns of the danger of material damage.
	CAUTION warns of the danger of slight injury.
	WARNING warns of a danger that may lead to death or serious injury.
	DANGER warns of a danger that will lead to death or serious injury unless avoided.



The information symbol provides supplemental information on the operation of the machine and points to complementary technical information.

4.1. Information and safety stickers

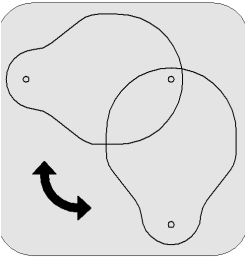
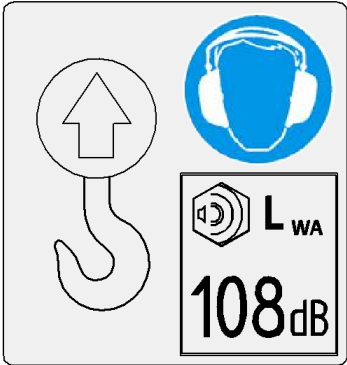
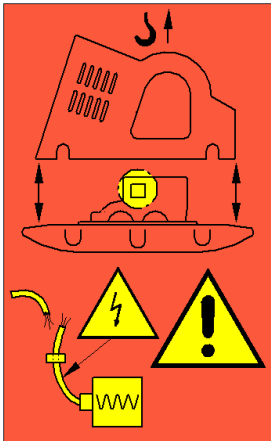
	Sticker	Meaning
1	<p>Alle Schraubenverbindungen ständig auf festen Sitz überwachen! -Besonders nach dem ersten Einsatz-</p> <p>Continuously check all screwed connections for firm seating -particularly after initial employment-</p> <p>Controler continuellement tous les raccords a vis pour un siege ferme -particulierement apres l'emploi initial-</p>	All threaded unions must be checked for firm seat on a regular basis and, particularly, after initial use.
2		The fuel tank may only be fueled with diesel.
3		Turn the gas cap to open and close it.
4		Use the designated lifting ring to lift the machine. Sound power level 108 dB (A), Wear ear protection.
5*		When disconnecting the engine bracket from the base plate, make sure not to damage the sensor cable. The sensor must be detached from the base plate.

*Only units equipped with COMPATROL 2.0 compaction control.

5. Operation

Preparing the machine for initial use

- ▶ Remove all packaging material.
- ▶ Check all components for visible damage. Do not start the machine if detecting visible damage. Contact the responsible dealer.
- ▶ Check if the shipment of the machine and its components is complete.
- ▶ Check the fill level of the operating fluids and top off if necessary.
- ▶ Set up the machine at its place of use.

Operating positions on the machine

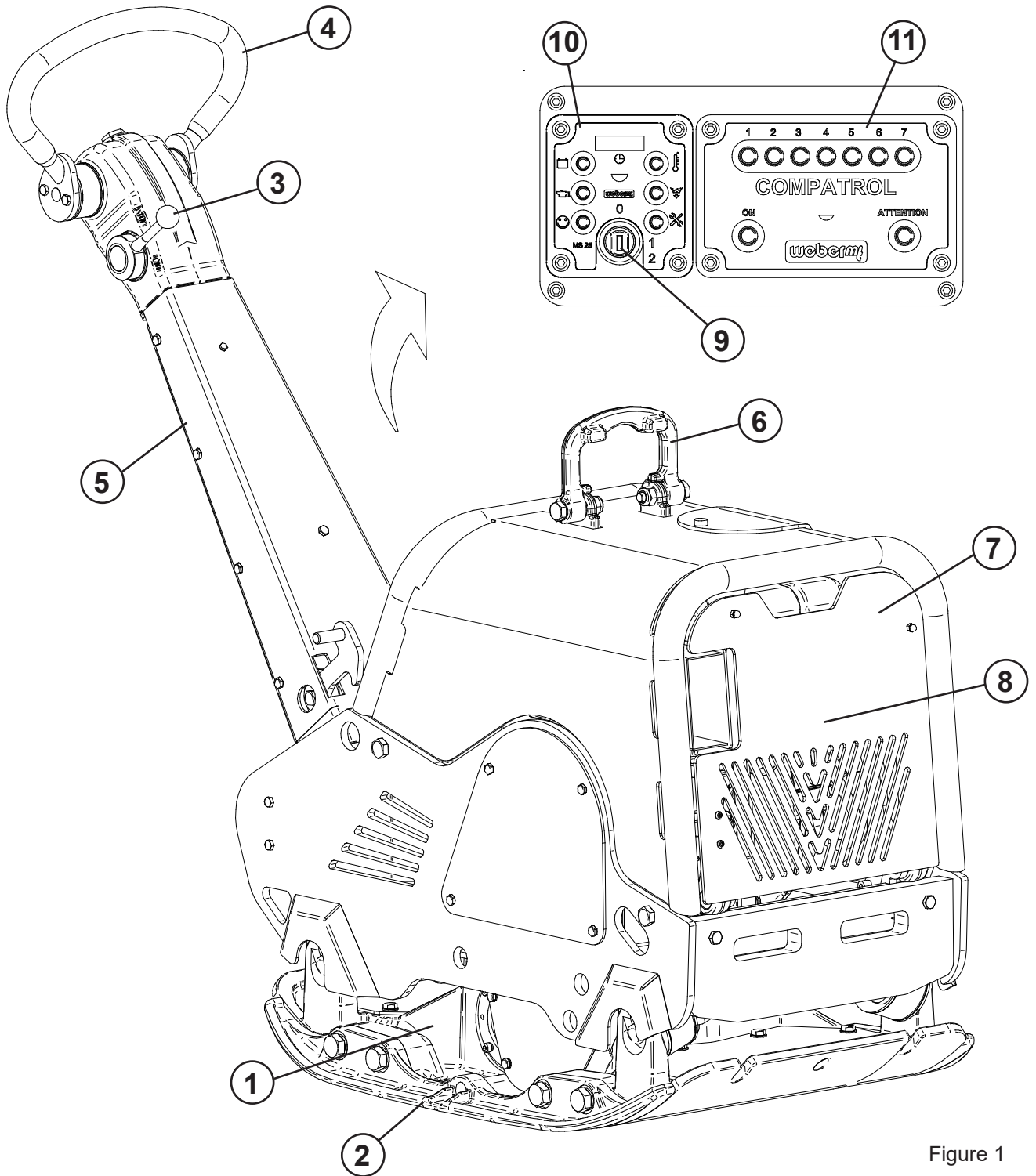

Figure 1

Overall view CR 6

- | | | | |
|---|-------------------------|------|---|
| 1 | Base plate with exciter | 7 | Maintenance cover |
| 2 | Mounting bracket | 8 | Engine (no image) |
| 3 | Gas lever | 9 | Key switch |
| 4 | Handle | 10* | Start module |
| 5 | Guide bar | 11** | Compaction control system Compatrol 2.0 |
| 6 | Lifting ring | | |

* Figure shows the start module MS 25 (MDM / Compatrol 2.0).

**Only units equipped with COMPATROL 2.0 compaction control.

The start module

MS 15 (CR 6)

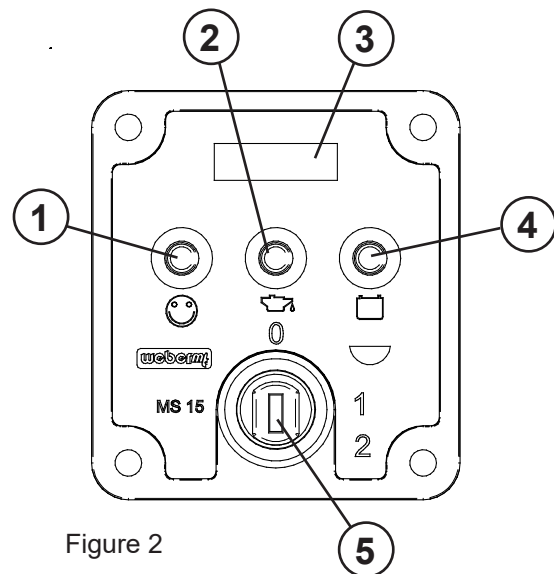

Figure 2

1 Operational status indicator (LED)

This indicator signals that the ignition of the machine is switched on. It comes on as soon as the key switch (5) is set to position "1".

2 Oil pressure indicator (LED)

This indicator warns of insufficient oil pressure. Shut down the machine immediately when this indicator comes on.

3 Operating hours counter

This field shows the operating hours completed by the machine.

The counter will show the remaining time until the next scheduled maintenance for the first 10 seconds after the ignition was switched on (key switch (5) in position "1").

4 Charge level indicator (LED)

This indicator comes on if the charging current supply to the starter battery is insufficient. While operation of the machine can resume, the cause of the insufficient charging current supply must be identified and rectified.

5 Key switch

The key switch is used to switch the power supply (ignition) to the machine on or off. It also actuates the electric starter of the engine.

▶ Switch in position "1"
✓ The ignition is switched on.

▶ Switch in position "0"
✓ The ignition is switched off.

▶ Switch in position "2"
✓ The electric starter is actuated.

ATTENTION

Danger of material damage from running electric starter. The ignition key must spring back from position "2" to position "1". Otherwise:

▶ Shut down the machine immediately.

MS 25 & 35 (CR 6 MDM & CCD)

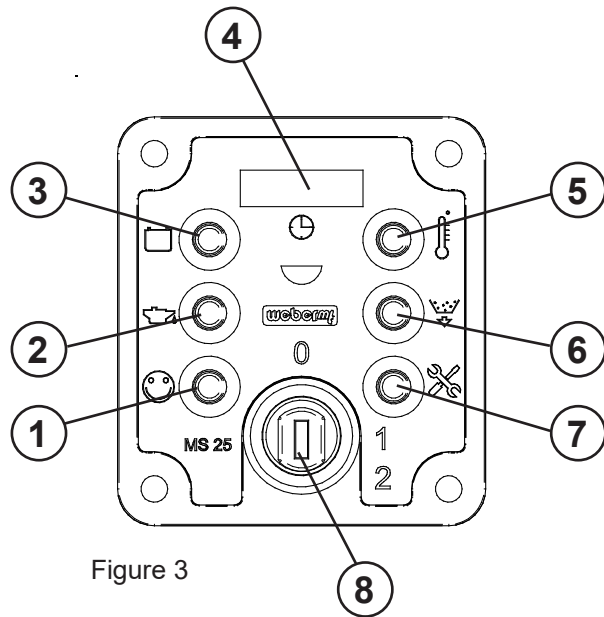

Figure 3

1 Operational status indicator (LED)

This indicator signals that the ignition of the machine is switched on. It comes on as soon as the key switch (5) is set to position "1".

2 Oil pressure indicator (LED)

This indicator warns of insufficient oil pressure. Shut down the machine immediately when this indicator comes on. The engine is switched off automatically.

3 Charge level indicator (LED)

This indicator comes on if the charging current supply to the starter battery is insufficient. While operation of the machine can resume, the cause of the insufficient charging current supply must be identified and rectified.

4 Operating hours counter

This field shows the operating hours completed by the machine.

The counter will show the remaining time until the next scheduled maintenance for the first 10 seconds after the ignition was switched on (key switch (5) in position "1").

5 Temperature indicator (LED)

This indicator comes on if the engine is overheating. Shut down the machine immediately when this indicator comes on. The engine is shut down automatically 3 minutes after the indicator comes on.

6 Air filter indicator (LED)

This indicator comes on in case of heavy fouling of the air filter. Shut down the machine immediately when this indicator comes on. The engine is shut down automatically 10 minutes after the indicator comes on.

7 Maintenance indicator (LED)

This indicator comes on 10 operating hours before the next scheduled maintenance interval.

8 Key switch

The key switch is used to switch the power supply (ignition) to the machine on or off. It also actuates the electric starter of the engine.

- ▶ Switch in position “1”
 - ✓ The ignition is switched on.

- ▶ Switch in position “0”
 - ✓ The ignition is switched off.

- ▶ Switch in position “2”
 - ✓ The electric starter is actuated.

ATTENTION

Danger of material damage from running electric starter. The ignition key must spring back from position “2” to position “1”. Otherwise:

- ▶ Shut down the machine immediately.

The COMPATROL compaction control system

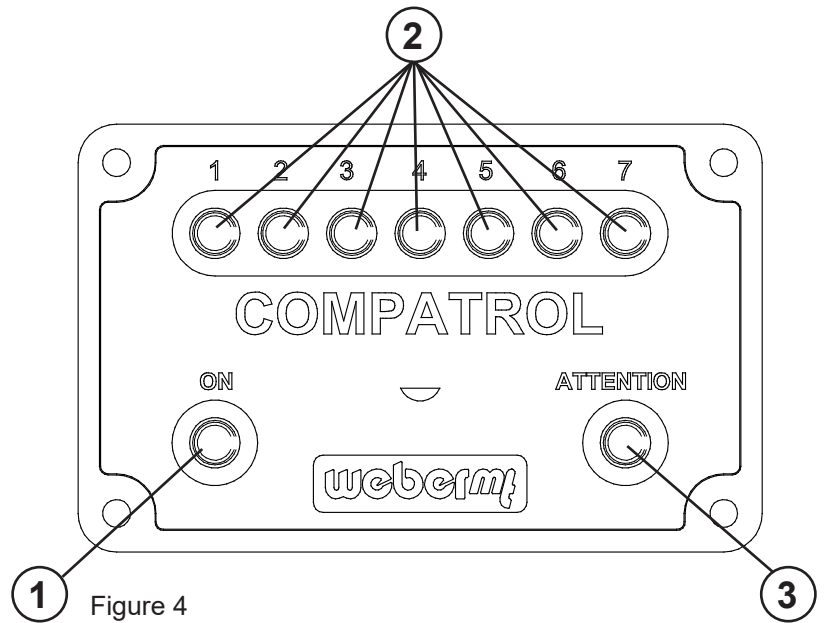

1 Operational status indicator (Green)

This indicator comes on as soon as the proper operating frequency has been reached and signals that the compaction control system is operational.
If the indicator flashes constantly, the machine is operating with the wrong operating frequency.

2 Compaction indicator (Yellow)

The LEDs 1-7 indicate the achieved level of soil compaction. The number of lit LEDs increases with the level of compaction. If no additional LED comes on after another pass over the same spot, the maximum level of compaction has been reached.

3 Warning light (Red)

The warning light warns of operation on soils that are too hard. These types of soil cannot be compacted further with the machine type used and may result in damage to the machine.

Possible indicator states

Function test of the LEDs

A function test of the LEDs is performed when the ignition is turned on, but the engine has not yet been started.

The operational status indicator (1) and the warning light (3) light up permanently.

The LEDs of the compaction indicator (2) light up in succession from left to right and go out in reverse order.

After engine start, before reaching the operating frequency

The warning light (3) signals by lighting up permanently that the compaction indicator is not operational yet.

The LEDs of the compaction indicator (2) are not yet lit.

The operational status indicator (1) signals by flashing that the operating frequency has not been reached yet.

Reaching the operating frequency, operation

Upon reaching the operating frequency, the operational status indicator (1) lights up permanently, indicating that the machine is ready for operation.

The warning light (3) goes out.

The compaction indicator (2) starts lighting up, indicating the achieved level of soil compaction.

Illumination of the warning light

The warning light warns of operation on soils that are too hard.

If all LEDs of the compaction indicator (2) are lit together with the warning light (3), the soil to be compacted is too hard. Stop operation immediately to avoid damage to the machine.



The attainable maximum may vary with the type and composition of the soil. On sand, the maximum is commonly reached at a low number of lit LEDs.

Following the compaction of a mix of gravel and crushed rock that is uniformly graded and contains the proper concentration of water, the indicator is likely to show six to seven lit LEDs.

It is important to closely monitor the indicator during the last pass. Places where the number of lit LEDs drops sharply are poorly compacted. In these places, the soil needs to be compacted again or may even have to be replaced.

Before starting work

Perform the following tasks before starting to work in order to prevent failures or excessive wear.

Visual inspections

- ▶ Hydraulic line for leaks
- ▶ Fuel system for leaks
- ▶ Rubber buffers for crack formation
- ▶ Other damage

Check and, if necessary, correct the fill levels

- ▶ Engine oil
- ▶ Hydraulic oil
- ▶ Fuel

Other inspections

- ▶ Check all threaded unions for firm seat
- ▶ Verify compliance with the maintenance schedule

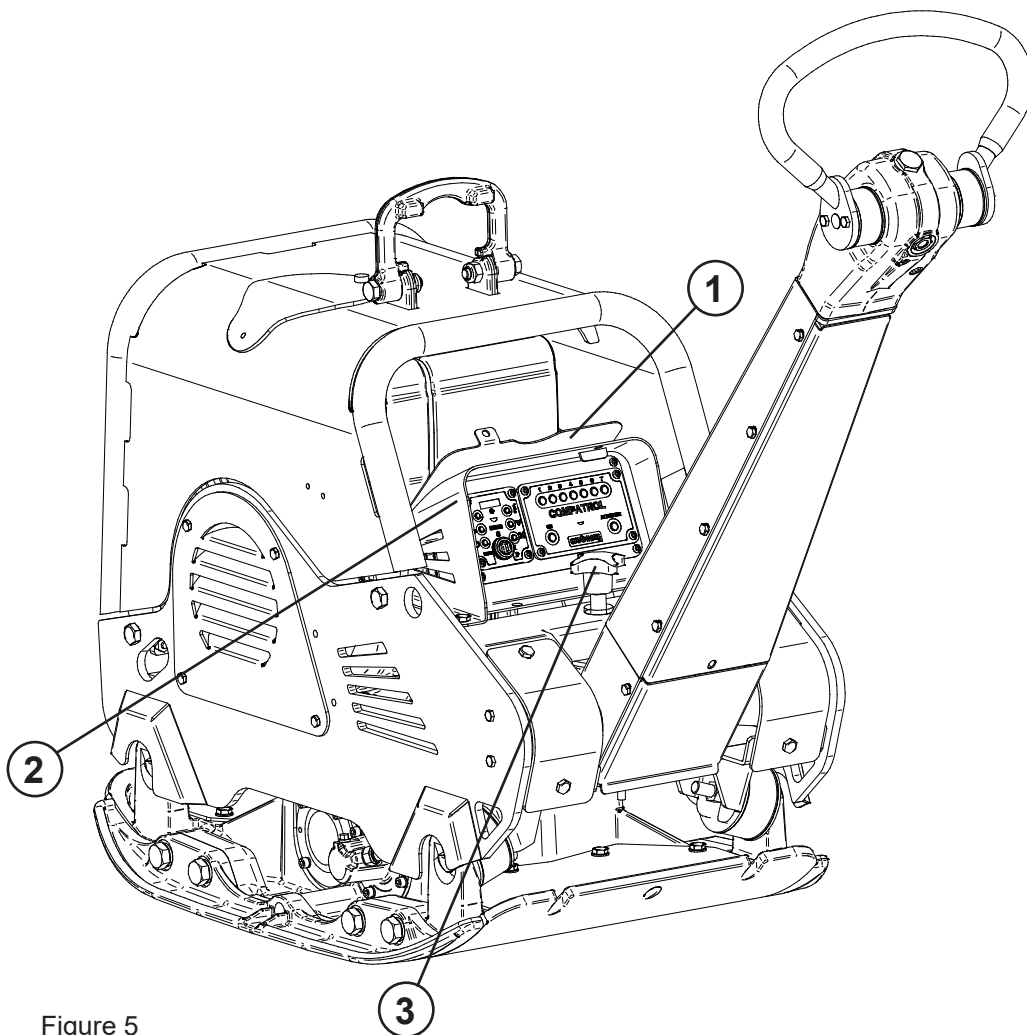

Figure 5

Working with the machine

Starting the engine

ATTENTION

Risk of engine damage if start procedures take too long. One start procedure must not be longer than 30 seconds. If the engine fails to turn over, the cause must be identified and rectified.

ATTENTION

Risk of engine damage. The use of starter spray may lead to overheating in the combustion chamber.

- ▶ Do not use any starter spray.

▲ WARNING

Danger of suffocation from engine exhausts when starting the engine in closed rooms or poorly ventilated work areas.

- ▶ Start the engine only in well-ventilated environments.
 - ▶ See section “Safety” for operating the machine in trenches.
-
- ▶ Adjust the desired work height of the guide bar with the set screw (position 3, figure 5).
 - ▶ Open the vandalism flap (position 1, figure 5).
 - ▶ Insert the vandalism flap (1) into the designated holder on the valve box (position 2, figure 5).
 - ▶ Bring the gas lever into the full-throttle position “ON”.
 - ▶ Turn the ignition key to position “2” and hold it until the engine turns over.
 - ▶ Release the ignition key as soon as the engine is running. **ATTENTION!** Danger of material damage from running electric starter.
The ignition key must spring back to position “1” automatically. Otherwise, shut down the machine immediately.
 - ▶ Set the gas lever to the idle speed “STOP”.
 - ✓ The operational status indicator ☺ signals that the machine is ready for operation.

Compacting

CAUTION

There is a crushing hazard between the machine and the wall during work in close proximity to walls.

- ▶ Use extra caution when working close to obstacles.

CAUTION

Risk of injury if the machine is guided improperly.

- ▶ Guide the machine safely with both hands on the handle.

ATTENTION

Danger of material damage or excessive wear if V-belt slips through.

- ▶ Operate the machine only in full-throttle mode, gas lever position "ON".

ATTENTION

Risk of damage to the machine. Never work on soils that cannot be compacted further. The optional COMPATROL 2.0 compaction control system warns of hard soils.

If all LEDs of the compaction indicator light up together with the warning light, stop operation immediately.

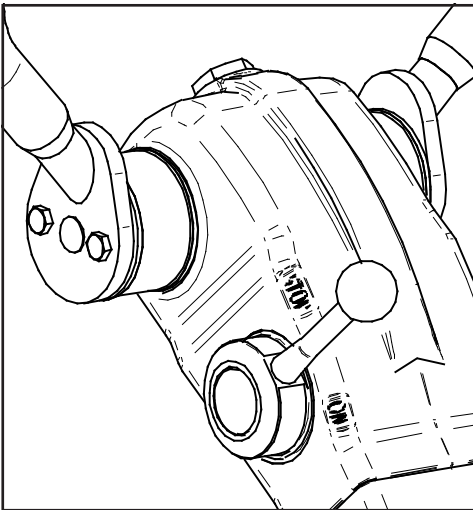

- ▶ Start the engine.
- ▶ Bring the gas lever into the full-throttle position "ON".
- ▶ Switch between forward and reverse travel by setting the handle to the corresponding direction.



The forward and reverse travel of the machine is infinitely variable.

The speed of the machine is selected with the corresponding deflection of the handle.



If the machine is equipped with the COMPATROL compaction control system, the achieved compaction of the soil can be read in the display.

The maximum possible compaction has been reached when no additional LEDs come on after the completion of another pass.

Switching off the engine

- ▶ Bring the gas lever into the idle speed position "STOP".
- ▶ Turn the ignition key to position "0".
- ▶ If necessary, pull out the ignition key and close the vandalism flap.

6. Transport

Lifting the machine

The machine can be lifted for loading onto a vehicle.

CAUTION

Risk of material damage and injuries. The use of defective or unsuitable lifting gear may cause the machine to fall down.

- ▶ Use slings that possess the appropriate carrying capacity.
- ▶ Lock the guide bar in place in the folded position.
- ▶ Fit the crane hook into the lifting ring and lift the machine up straight.

7. Storage

Storage at the construction site

If stored at the construction site, e.g. over night, the machine must be secured against theft and unauthorized use.

Parked machines presenting an obstacle must be secured in accordance with statutory regulations, particularly in the area of public traffic surfaces.

Storage for an extended period

If the machine will not be used for a period longer than one month, the following measures must be taken:

- ▶ Clean the entire machine thoroughly.
- ▶ Check the entire machine for leaks. Correct any detected defects.
- ▶ Empty fuel and fill the tank with clean fuel.
Check and, if necessary, correct the engine oil level.
- ▶ Check and clean air and fuel filter. Replace if damaged.
- ▶ Lightly oil all bare parts, levers and accelerator control cables.
- ▶ Check the charging status of the battery, recharge if necessary.
- ▶ Check the charging status of the battery on a regular basis, but not less than every 3 months. Another option is to use a permanent charger / battery maintainer.



If the machine is to be stored for longer than six months, contact the Weber MT's service organization to discuss additional measures.

8. Maintenance

General information

The section below contains instructions that need to be observed for regular maintenance. Read these instructions carefully and follow them in order to prevent downtimes of the machine caused by excessive wear or damage to the machine. Also read the safety instructions relevant to machine maintenance before you begin with the maintenance work. They help minimize the risk to maintenance personnel.

Maintenance personnel

Maintenance and repairs require specific qualifications. These operations may only be carried out by trained professionals. Maintenance personnel must be instructed on how to operate the machine by the owner or by the owner's assigned personnel.

Maintenance personnel are required to wear the personal protective equipment during work (see section "Safety").

Safety

There is an increased risk of injury during maintenance and repairs, e.g. crushing at moving parts.

Following the conclusion of all maintenance and repairs, all protective fixtures must be refitted and placed back into operation.

Discharged operating fluids have a negative impact on the environment. They must be collected and stored in suitable containers. Disposal in accordance with environmental protection regulations.

All maintenance work may only be carried out when the engine is cold. Safeguard the engine against unauthorized start attempts.

Before working on the electrical system, disconnect the starter battery and cover the battery terminals with insulating material. It is also recommended to disconnect the battery as a means to safeguard the machine against unauthorized start attempts during maintenance work.

Before starting the machine after maintenance operations, make sure that all loose parts (screws, tool, etc.) have been removed from the machine. They may be drawn in or flung off by moving parts.

Keep the entire machine clean. The stickers must always be clearly legible. Damaged stickers must be replaced.

8.1. Maintenance overview

Activity	Frequency					See section
	Initial maintenance / after 25 operating hours	Every 8 operating hours / daily	Every 150 operating hours / every six months	Every 150 operating hours / every year	Every 250 operating hours	
Change the engine oil	X			X		8.2.4
Check the valve play of the engine, adjust if necessary	X				X	Hatz instructions
Re-tighten all accessible threaded connections	X					
Clean the air filter		X				8.2.1
Change the fuel filter			X			8.2.7
Clean the engine oil filter				X		8.2.5
Check the oil level of the transmission			X			8.2.8
Change the oil in the exciter				X		8.2.9



The regulations and the operating and maintenance manuals of the engine manufacturer must be complied with in addition to the activities specified in the above maintenance overview.

8.2. Description of the maintenance operations

8.2.1. Clean the air filter

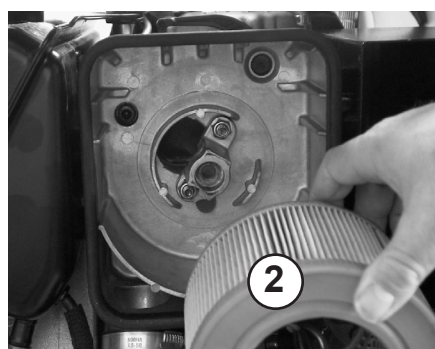
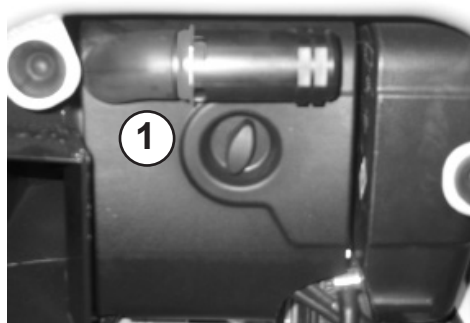

- ▶ Open the maintenance cover.
- ▶ Check the intake area for the combustion air.
- ▶ Remove larger objects that may clog the filter such as leaves or rocks.
- ▶ Unscrew the air filter cover (1).
- ▶ Remove the knurled nut on the air filter.
- ▶ Remove the air filter insert (2).
- ▶ **ATTENTION!** Danger of material damage from dirt particles.
- ▶ Keep dirt or foreign objects from entering the intake opening.
- ▶ Blow out the air filter insert from inside to outside with compressed air.
- ▶ Check and, if necessary, replace the air filter cartridge. See also Hatz instructions.
- ▶ Tighten the air filter cartridge using the knurled nut
- ▶ Screw on the air filter cover.
- ▶ Close the maintenance cover.

8.2.2. Check V-belt

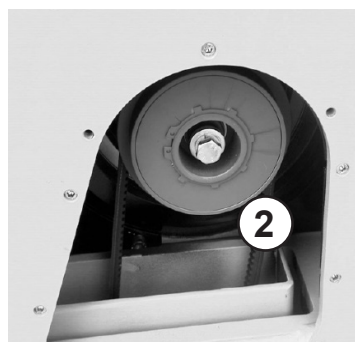
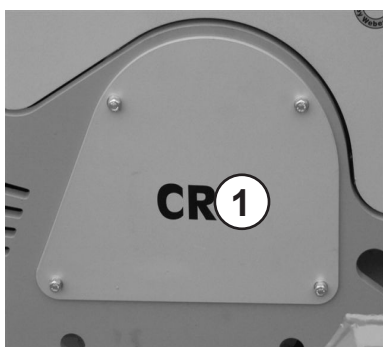

- ▶ Shut down the machine.
- ▶ Remove the V-belt guard (1).
- ▶ Check the V-belt (2) for cracks and wear.
- ▶ Replace the V-belt if it shows signs of extensive wear or other damage.
- ▶ Fit the V-belt guard.

8.2.3. Check the engine oil level

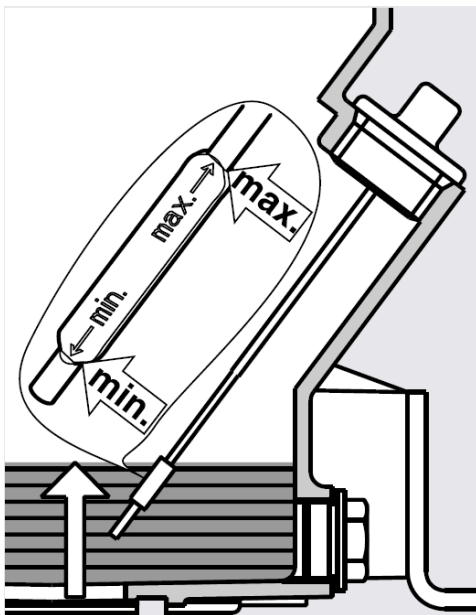
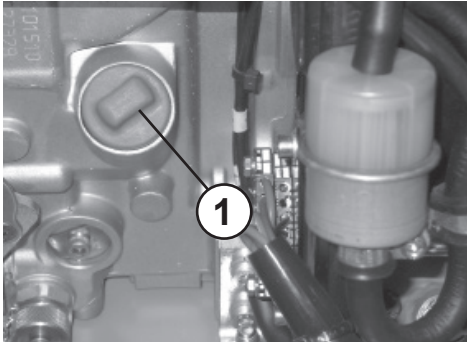

8.2.4. Change the engine oil

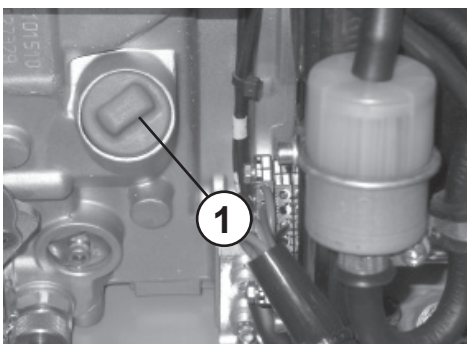

⚠ WARNING

If lubricating oils and fuel come into contact with skin, they can cause skin irritations.

- ▶ Wear protective gloves.
- ▶ If skin contact has occurred, wash the affected areas thoroughly.

- ▶ Park the machine on a horizontal subsurface. Switch off the engine and wait for several minutes until the oil has collected in the crankcase.

- ▶ Open the maintenance cover.

CAUTION! Danger of burn injuries at the hot engine and its attachments.

- ▶ Allow the combustion engine to cool down sufficiently before starting work.

- ▶ Unscrew the oil dip stick from the crankcase.

- ▶ Wipe off the oil dip stick with a clean cloth.

- ▶ Screw the oil dip stick back into the crankcase.

- ▶ Unscrew the oil dip stick from the crankcase.

- ▶ The correct oil level is between the “min.” and the “max.” marks.

- ▶ When the oil level reaches the “min.” mark, fill in fresh oil in accordance with the specification.

- ▶ Close the maintenance cover.

⚠ CAUTION

Danger of burn injuries at the hot engine and its attachments.

- ▶ Allow the combustion engine to cool down sufficiently before starting work.

- ▶ Use extra caution during work on the engine when it is at operating temperature.

- ▶ Start the engine and allow the engine to warm up for a few minutes.

- ▶ Switch off the engine.

- ▶ Open the maintenance cover.

- ▶ Unscrew the oil dip stick (1). It also serves as the seal for the oil filler neck.

- ▶ Place a suitable collection vessel under the oil drain.

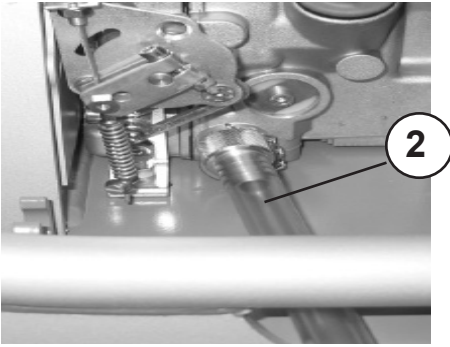

- ▶ Remove the cover cap from the oil drain valve
- ▶ Screw the oil drain hose (2) onto the oil drain valve.
 - ▲ CAUTION! Danger of scalding due to hot oil.
 - ▶ Wear protective gloves.
 - ▶ Use extra caution.
- ▶ Allow the oil to drain into the collection vessel.
- ▶ Unscrew the oil drain pipe.
- ▶ Attach the cover cap to the oil drain valve.
- ▶ Fill fresh oil into the engine in accordance with the specification.
- ▶ Check the oil level and top off to the “max.” mark.
- ▶ Screw in the oil dip stick.
- ▶ Close the maintenance cover.

8.2.5. Clean the engine oil filter

▲ CAUTION

Danger of burn injuries at the hot engine and its attachments.

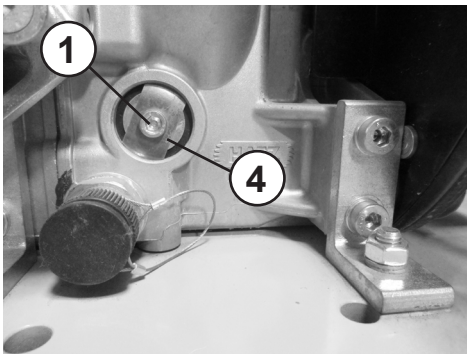

- ▶ Allow the combustion engine to cool down sufficiently before starting work.
- ▶ Use extra caution during work on the engine when it is at operating temperature.
- ▶ Drain the engine oil.
- ▶ Loosen the fastening screw of the oil filter (1) by approx. 5 turns.
- ▶ Grab the screw on the oil filter (2) and pull the filter out of the engine case.
- ▶ Blow out the oil filter from inside to outside with compressed air.
- ▶ Check the sealing rings (3) for firm seat. Replace them if they are damaged.
- ▶ Lightly oil the sealing rings.
- ▶ Press the oil filter into the engine case.
- ▶ Tighten the fastening screw. While doing so, ensure that the tension spring (4) rests on the oil filter.
- ▶ Fill fresh engine oil into the filler neck.

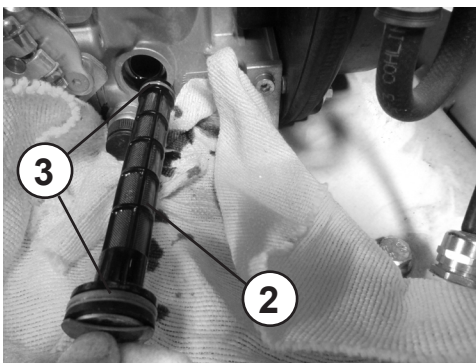

⚠ CAUTION

Risk of environmental pollution from spilled fuel. During the draining of the water held in the water separator, a small amount of fuel is drained along with the water.

▶ Collect the fuel-water mix and dispose of it in accordance with local environmental protection regulations.

▶ Open the maintenance cover.

▶ Place a transparent vessel under the drain plug (1).

▶ Unscrew the drain plug (1) to one thread.

▶ Allow the fuel-water mix to drain into the transparent vessel until only pure fuel flows from the plug.

▶ Seal the plug tightly again.

8.2.6. Check the water separator

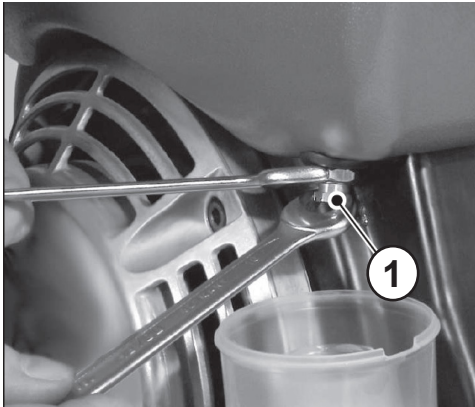

8.2.7. Change the fuel filter

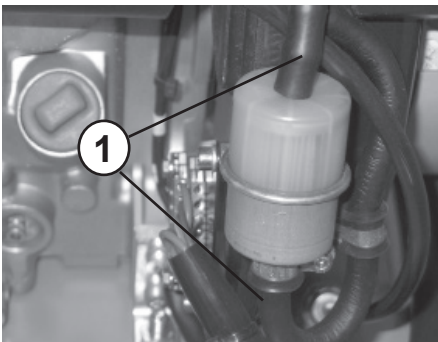

▶ Open the maintenance cover.

▶ Drain the fuel tank into a suitable clean vessel.

▶ Pull the fuel line (1) off the fuel filter on both sides.

▶ Insert a new fuel filter.

▶ Fill the fuel tank.

▶ Close the maintenance cover.

8.2.8. Check the hydraulic oil level

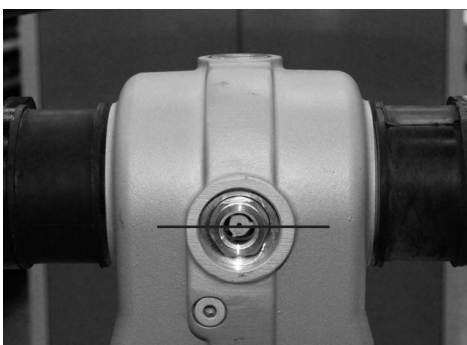

▶ Lock the guide bar in place in the transport position.

▶ Check the hydraulic oil level.

The oil level is correct when the oil is in the middle of the view glass.

8.2.9. Change the oil in the exciter

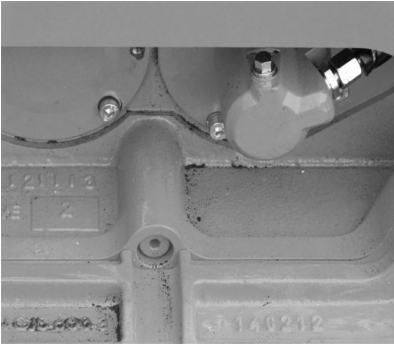

- ▶ Start the engine and allow the engine to warm up for a few minutes.
- ▶ Switch off the engine.
- ▶ Tilt the machine slightly.
- ▶ Place a suitable collection vessel under the machine.
- ▶ Loosen the oil drain plug (1).
- ▶ Allow the oil to drain.
- ▶ Tilt the machine in the other direction.
- ▶ Fill fresh oil into the exciter in accordance with the specification.
- ▶ Close the oil drain plug.

8.2.10. Change the fuses

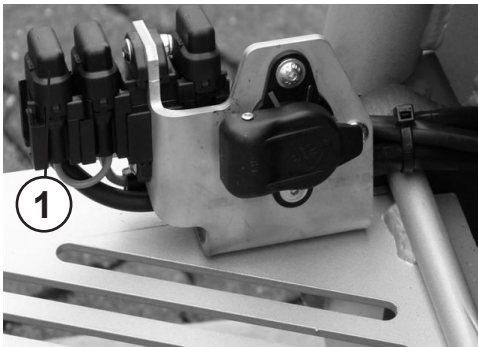

- ▶ Open the maintenance cover.
- ▶ Remove the protective caps (1) of the fuse holder.
- ▶ Replace defective fuses.
- ▶ Attach the protective caps to the fuse holder.
- ▶ Close the maintenance cover.

8.2.11. Use a permanent charger

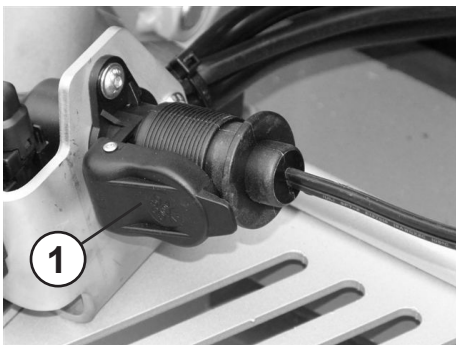

- ▶ Open the maintenance cover.
- ▶ Open the protective cover (1) of the charging socket.
- ▶ Connect the permanent charger to the charging socket.
- ▶ Connect the permanent charger to the appropriate mains supply.



Comply with the manufacturer's operating manual when using the permanent charger! The operating manual is included with every permanent charger.

8.3. Operating fluids and fill levels

Assembly	Operating material	Quantity
Engine Engine oil	SAE 10 W 40 (-10 ~ + 50 °C) API - CD CE-CF-CG or SHPD or CCMC - D4 - D5 - PD2	1.5 l
Fuel tank	Diesel Diesel in accordance with DIN 51601-DK or BS2869-A1/A2 or STM D975-1D/2D	5.0 l
Vibrator	Fully-synthetic transmission fluid API GL-5/GL-4 First filling Fuchs Titan SINTOPOID LS SAE 75W-90	0.75 l
Gearshift	Transmission fluid DEXRON II-D-ATF First filling Fuchs Titan ATF 3000 or equivalent	As necessary



facebook.com/WeberMT



youtube.com/MyWeberMT



Weber Maschinenteknik GmbH

Im Boden 5-8, 10 · 57334 Bad Laasphe · Germany
Phone +49 2754 398 0 · Fax +49 2754 398 101
info@webermt.de · www.webermt.de

085101258-104 / CR 6 Hatz_2020-08
Original operating manual