

## E 3838-0820

Position Ref.No. Repère Posizione Posicion	Menge Quantity Quantité Quantita Cantidad	Teile-Nr. Part-No. No. Référence Nr. d'Ordine No. Referenzia	Hinweis Hints Indications Indicazione Indicaciones	Position Ref. No. Repère Posizione Posicion	Menge Quantity Quantité Quantita Cantidad	Teile-Nr. Part-No. No. Référence Nr. d'Ordine No. Referenzia	Hinweis Hints Indications Indicazione Indicaciones
1	1	11002552					
2	4	20005019					
3	4	25049006	DIN440-R14				
4	4	25038015	DIN933-M10x30				
5	4	20029033	SKM 10				
6	1	11002555					
7	4	25038022	DIN933-M12x40				
8	8	20029023	SKB 12				
9	4	25031027	DIN1587-M12				

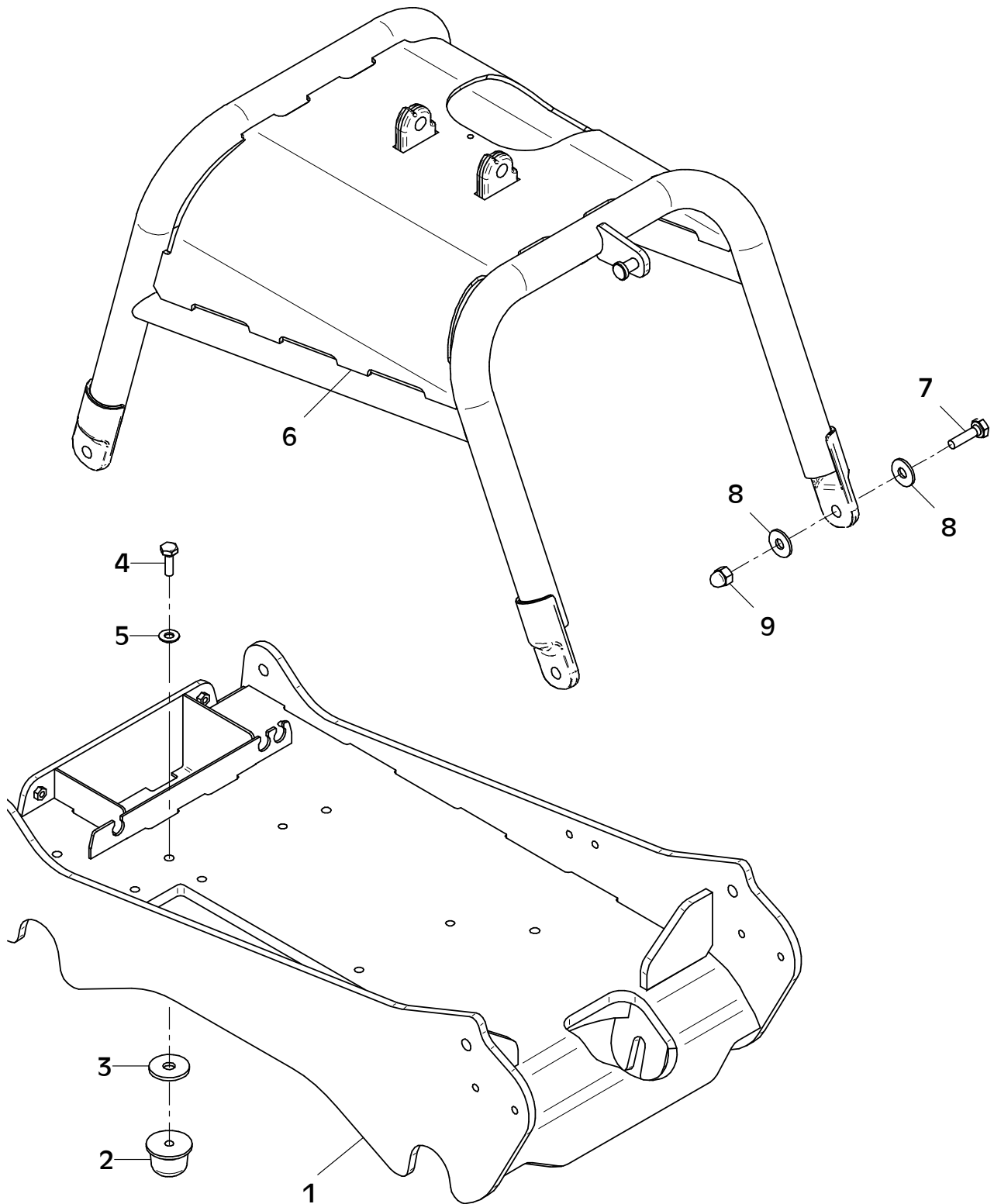

## E 3839-0820

Position Ref.No. Repère Posizione Posicion	Menge Quantity Quantité Quantita Cantidad	Teile-Nr. Part-No. No. Référence Nr. d'Ordine No. Referenzia	Hinweis Hints Indications Indicazione Indicaciones	Position Ref. No. Repère Posizione Posicion	Menge Quantity Quantité Quantita Cantidad	Teile-Nr. Part-No. No. Référence Nr. d'Ordine No. Referenzia	Hinweis Hints Indications Indicazione Indicaciones
1	1	11002553					
2	4	20005019					
3	4	25049006	DIN440-R14				
4	4	25038015	DIN933-M10x30				
5	4	20029033	SKM 10				
6	1	11002555					
7	4	25038022	DIN933-M12x40				
8	8	20029023	SKB 12				
9	4	25031027	DIN1587-M12				

CR 5-II  
CR 5-II E

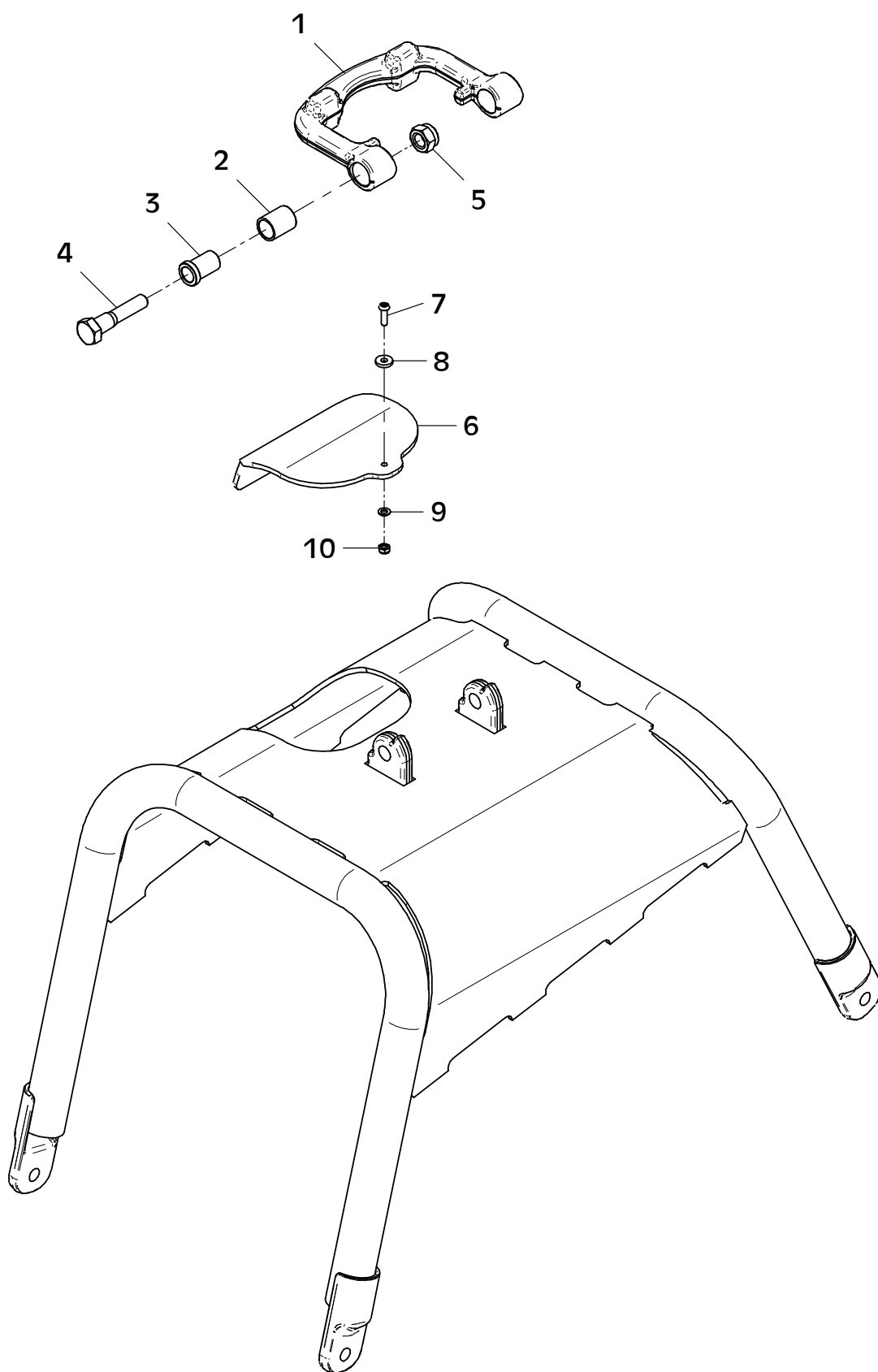

E 3840-0820

## E 3840-0820

Position Ref.No. Repère Posizione Posicion	Menge Quantity Quantité Quantita Cantidad	Teile-Nr. Part-No. No. Référence Nr. d'Ordine No. Referenzia	Hinweis Hints Indications Indicazione Indicaciones	Position Ref. No. Repère Posizione Posicion	Menge Quantity Quantité Quantita Cantidad	Teile-Nr. Part-No. No. Référence Nr. d'Ordine No. Referenzia	Hinweis Hints Indications Indicazione Indicaciones
1	1	10017337					
2	2	21000031					
3	2	11000148					
4	2	25040022	DIN931-M16x70				
5	2	25031017	DIN985-M16				
6	1	11000791					
7	1	25033030	ISO7380-M6x20-10.9				
8	1	25049034	DIN7349-6,4				
9	1	25048001	DIN125-A6,4				
10	1	25031012	DIN985-M6				