

# Operating and Maintenance Manual

**weber** *mf*



**CR 2 Hd**

0115614

Attached to the machine is a rating plate. Note down the information given on this plate so that you can recreate the rating plate should the plate be lost.

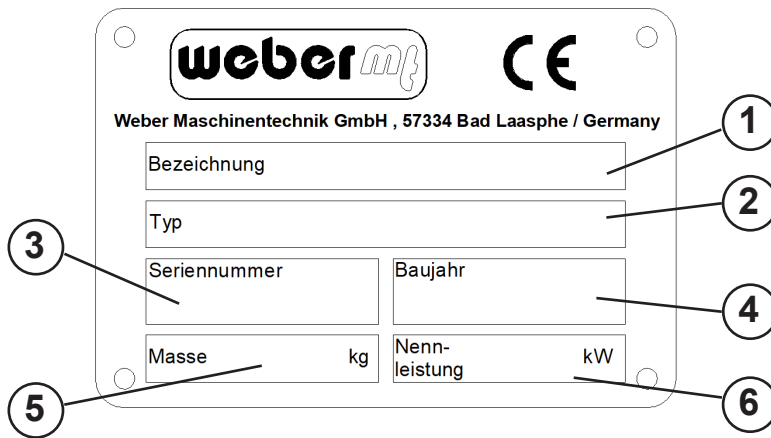

**1 Description**

.....

**2 Type**

.....

**3 Serial number**

.....

**4 Year of construction**

.....

**5 Mass [kg]**

.....

**6 Rated power [kW]**

.....

# Contents

|   |           |
|---|-----------|
| <b>1. Introduction</b> .....                                | <b>4</b>  |
| <b>2. Description</b> .....                                 | <b>5</b>  |
| <b>3. Technical data</b> .....                              | <b>6</b>  |
| <b>4. Safety</b> .....                                      | <b>7</b>  |
| 4.1. Information and safety stickers .....                  | 12        |
| <b>5. Operation</b> .....                                   | <b>13</b> |
| <b>6. Transport</b> .....                                   | <b>18</b> |
| <b>7. Storage</b> .....                                     | <b>18</b> |
| <b>8. Maintenance</b> .....                                 | <b>19</b> |
| <b>8.1. Maintenance overview</b> .....                      | <b>20</b> |
| <b>8.2. Description of the maintenance operations</b> ..... | <b>21</b> |
| 8.2.1. Check the engine oil level .....                     | 21        |
| 8.2.2. Change the engine oil .....                          | 21        |
| 8.2.3. Clean the air filter .....                           | 22        |
| 8.2.4. Check the hydraulic oil level .....                  | 23        |
| 8.2.5. Change the oil in the exciter .....                  | 23        |
| 8.2.6. Check V-belt.....                                    | 23        |
| 8.2.7. Adjust/replace the spark plug .....                  | 24        |
| <b>8.3. Operating fluids and fill levels</b> .....          | <b>25</b> |

# 1. Introduction

This operating and maintenance manual is designed to help you become familiar with your soil compactor and enable you to maintain it and use it for its intended purpose.

The safety and maintenance instructions provided in this manual will help avoid hazards, reduce repair and downtime costs and will increase the reliability and operational readiness of your machine. Follow these instructions precisely.

This operating and maintenance manual must always be kept at the implementation site of the machine and be available to the machine operator.

Enclosed with this manual is a valid declaration of conformity and a spare parts lists for orders of spare parts. Store these documents carefully.

Turn to your Weber MT dealer if you require any additional information.

Found on the last page of this manual is a QR code. Scan it to acquire the current contact addresses of all Weber MT branches.

You can obtain information on the assembled Honda gasoline engine and the associated operating and maintenance manual as well as the spare parts list, if needed, at [www.honda-engines-eu.com](http://www.honda-engines-eu.com)

## 2. Description

### The machine

The machine is a hand-guided, reversible soil compactor. The machine is composed of a bottom and a top section. The bottom section houses the exciter, while the top section contains the engine and the required controls.

An air-cooled Honda gasoline engine makes the exciter vibrate via a centrifugal clutch. The generated force is transmitted between top and bottom section via a V-belt.

The engine speed is adjusted between idle speed and full-throttle speed via a gas lever. Forward and reverse travel is variably controlled with a handle via a hydraulic system.

### 3. Technical data

|   | CR 2 Hd            |
|---|--------------------|
| <b>Weight</b>   |                    |
| Operating weight CECE [kg]  | 143                |
| <b>Dimensions</b>   |                    |
| Overall length [mm]   | 1215               |
| Overall width/with attachment plates [mm]   | 450                |
| Height with folded guide bar [mm]   | 1065               |
| Base plate length [base in mm]  | 200                |
| Pressure surface [mm]   | 450x200            |
| <b>Drive</b>  |                    |
| Engine manufacturer   | Honda              |
| Type  | GX 160             |
| Performance at operating speed in accordance with ISO 3046-1 [kW]   | 2.7                |
| Combustion process  | 4-stroke gasoline  |
| Operating speed [1/min]   | 3350               |
| Operating speed [soil-dependent, m/min]   | 21                 |
| Incline capacity [soil-dependent, %]  | 35                 |
| <b>Vibration</b>  |                    |
| System  | Two-shaft vibrator |
| Drive concept   | Mechanical         |
| Frequency [Hz]  | 100                |
| Centrifugal force [kN]  | 25                 |
| <b>Noise emissions in accordance with 2000/14/EC</b>  |                    |
| Sound pressure level LPA ascertained in accordance with EN 500, [dB (A)]  | 98                 |
| Sound power level LWA ascertained in accordance with EN ISO 3744 and EN 500, [dB (A)]                                 | 108                |
| <b>Vibration values</b>   |                    |
| Root-mean-square acceleration value for hand-arm vibration ascertained in accordance with EN 500, [m/s <sup>2</sup> ] | 3.6                |
| In accordance with directive 2006/24/EC, complying with the vibration values is the owner's responsibility            |                    |

## 4. Safety

### General

All safety instructions must be read and complied with, as non-compliance will result in

- danger to life and limb of the user,
- impairments to the machine or other property.

In addition to the operating manual, the accident-prevention regulations in the country where the appliance is used must be complied with.

### Intended use

The machine should only be used in technically faultless condition, as intended, in a safety-conscious and hazard-conscious manner, and in compliance with the instructions in the operating manual.

Malfunctions that may impair safety require that you stop working with the machine immediately. These types of damage must be reported and corrected without delay.

The machine is designed exclusively for compacting:

- sand,
- gravel,
- crushed rock,
- low-cohesive mixed material,
- asphalt,
- paved surfaces.

The operator's work position is behind the machine. The operator must guide the machine safely with both hands on the handle.

### Non-intended use

Unless used as intended, the machine involves a risk of personal injury and property damage. The machine is expressly not suitable for:

- compacting frozen subsurfaces,
- compacting hard soils that cannot be compacted further,
- compacting non-bearing material,
- compacting highly cohesive soils,
- compacting (ramming) that exerts point loads on the base plate,
- crushing and compacting individual rocks.

The responsibility for any damage arising from non-intended use falls on the owner/operator.

Non-intended use or misuse will void all liability and warranty claims.

### Residual risk

There is always an increased risk of accidents in the immediate danger area around the machine if the operator fails to notice persons in the vicinity of the machine.

Anyone close to the machine must be made aware of this risk. The operator must not put the machine into operation unless everyone in the vicinity of the machine is aware of this risk.

**Requirements on the operator** This soil compactor may only be operated by suitable operators who are 18 years or older. They must be instructed on how to operate the machine by the owner or by the owner's assigned personnel. The operator must comply with traffic regulations.

The machine must not be operated by children.

**Personal protective equipment** Personal protective equipment consisting of

- hard hat,
- hearing protection,
- protective gloves,
- work shoes or boots with toe guard

must be worn during operation and the execution of maintenance on the machine.

**Danger areas** The immediate danger area is the direct perimeter around the machine. This area is off-limits to third parties.

**Spare parts, changes and conversions** Changes and conversions are prohibited unless made with original Weber MT spare parts. If the machine is modified with other accessories without the approval of Weber MT, the manufacturer will not assume liability for any resulting personal injury or property damage.

All maintenance and repairs must be carried out with original Weber MT spare parts. Untested spare parts may affect the reliability and safety of the machine.

**Before starting the machine** There is danger of material damage if the machine is started before necessary maintenance or repairs have been completed. Make sure every time before starting the machine that all work on the machine has been completed.

To avoid injuries, the machine must not be started unless the operator wears the required personal protective equipment.

Objects placed on top of the machine may fall or be flung off during operation or when the machine is started. Therefore, remove all loose objects or tools before starting the machine.

If the gas cap is open, fuel may escape and ignite on the engine when the machine is started or while it is operating. There is a risk of burns. Therefore, do not start the machine unless the gas cap is closed.



**Start-up procedure**

Do not disperse any sprays or other agents into the air intake while the machine is starting up. They may lead to overheating in the combustion chamber and result in damage to the engine.

There is danger of suffocation if the operator starts up the machine in closed rooms or in deep and tight trenches. Operating the machine in closed rooms is prohibited. Provide for an adequate supply of air before starting the machine.

**During operation**

Monitor the surroundings to avoid injury to third parties or material damage.

Suspend operation and shut down the machine if detecting damage on the machine during operation.

**Parking the machine**

Always park the machine on a level subsurface with sufficient bearing capacity.

Parked machines presenting an obstacle must be secured in accordance with statutory regulations, particularly in the area of public traffic surfaces.

Engine and exhaust heat up during operation and can cause burns on contact. Therefore, do not touch these components during operation or shortly after the machine was switched off.

**Fueling the machine**

Spilled fuel may ignite and has a negative impact on the environment. Therefore, wipe up spilled fuel and make sure the gas cap is firmly tightened after fueling.

When coming into contact with fuels, the rubber-bonded metal buffers of the machine may become damaged or ineffective. Therefore, wipe spilled fuel carefully off the rubber-bonded metal buffers.

Fuel vapors are easily flammable. Do not smoke and keep away from open fire while refueling the machine. The machine must not be fueled unless the engine is switched off.

**Cleaning work**

Use clear water for cleaning. Do not use flammable solvents. The vapors of the solvents may ignite upon contact with hot components or other sparks.

Perform cleaning tasks only in rooms that are suitable and have been approved for that purpose. Residual oil and lubricants that may have been rinsed off have a negative impact on the environment and must be collected by suitable means (e.g. oil separator).

**Safe handling of combustion engines**





Combustion engines pose a particular risk during operation. Their exhaust emissions contain carbon monoxide, a colorless and odorless gas that is extremely hazardous, which, if inhaled even briefly, can cause unconsciousness and death. Therefore, never inhale the exhaust gas.

**Inspection**

The machine must be inspected in accordance with the corresponding implementation conditions and operating conditions to ensure its operationally safe status. This inspection should be performed as needed by an expert – however, no less than once a year. The findings of the inspection must be stored in writing until the time of the next inspection.

## Safety instructions and warnings

A variety of safety instructions and warnings are used throughout this operating manual. The following explains the meaning of signal words and symbols.

|   |  |
|---|--|
|  | ATTENTION warns of the danger of material damage.                                  |
|  | CAUTION warns of the danger of slight injury.                                      |
|  | WARNING warns of a danger that may lead to death or serious injury.                |
|  | DANGER warns of a danger that will lead to death or serious injury unless avoided. |



The information symbol provides supplemental information on the operation of the machine and points to complementary technical information.

#### 4.1. Information and safety stickers

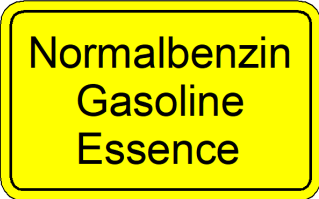
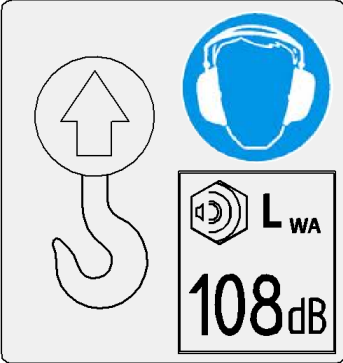
|   | Sticker  | Meaning  |
|---|--|--|
| 1 | <p><b>Alle Schraubenverbindungen ständig auf festen Sitz überwachen!</b><br/>-Besonders nach dem ersten Einsatz-</p> <p><b>Continuously check all screwed connections for firm seating</b><br/>-particularly after initial employment-</p> <p><b>Controler continuellement tous les raccords a vis pour un siege ferme</b><br/>-particulierement apres l'emploi initial-</p> | <p>All threaded unions must be checked for firm seat on a regular basis and, particularly, after initial use.</p>  |
| 2 |   | <p>The fuel tank may only be fueled with regular gasoline.</p>   |
| 3 |    | <p>Use the designated lifting ring to lift the machine.<br/>Sound power level 108 dB (A), wear ear protection.</p> |

## 5. Operation

### Preparing the machine for initial use

- ▶ Remove all packaging material.
- ▶ Check all components for visible damage. Do not start the machine if detecting visible damage. Contact the responsible dealer.
- ▶ Check if the shipment of the machine and its components is complete.
- ▶ Check the fill level of the operating fluids and top off if necessary.
- ▶ Set up the machine at its place of use.

## Operating positions on the machine

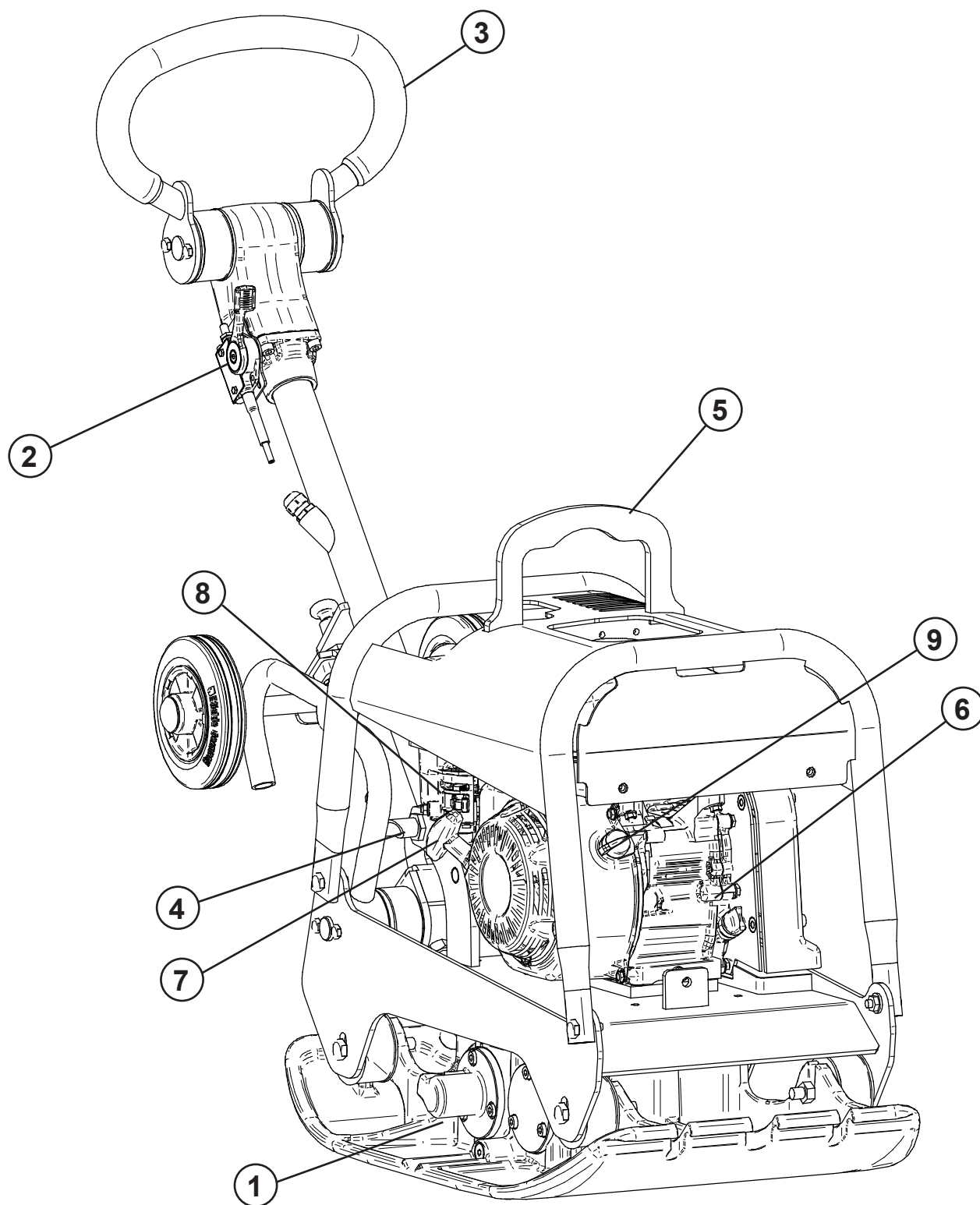

### Overall view CR 2 Hd

- 1 Base plate with exciter
- 2 Gas lever
- 3 Handle
- 4 Lock for the guide bar
- 5 Lifting ring

- 6 Engine
- 7 Reversing starter
- 8 Carburetor with choke and fuel cock
- 9 Short-circuit switch

## Before starting work

Perform the following tasks before starting to work in order to prevent failures or excessive wear.

### Visual inspections

- ▶ Hydraulic line for leaks
- ▶ Fuel system for leaks
- ▶ Rubber buffers for crack formation
- ▶ Other damage

### Check and, if necessary, correct the fill levels

- ▶ Engine oil
- ▶ Hydraulic oil
- ▶ Fuel

### Other inspections

- ▶ Check all threaded unions for firm seat
- ▶ Verify compliance with the maintenance schedule

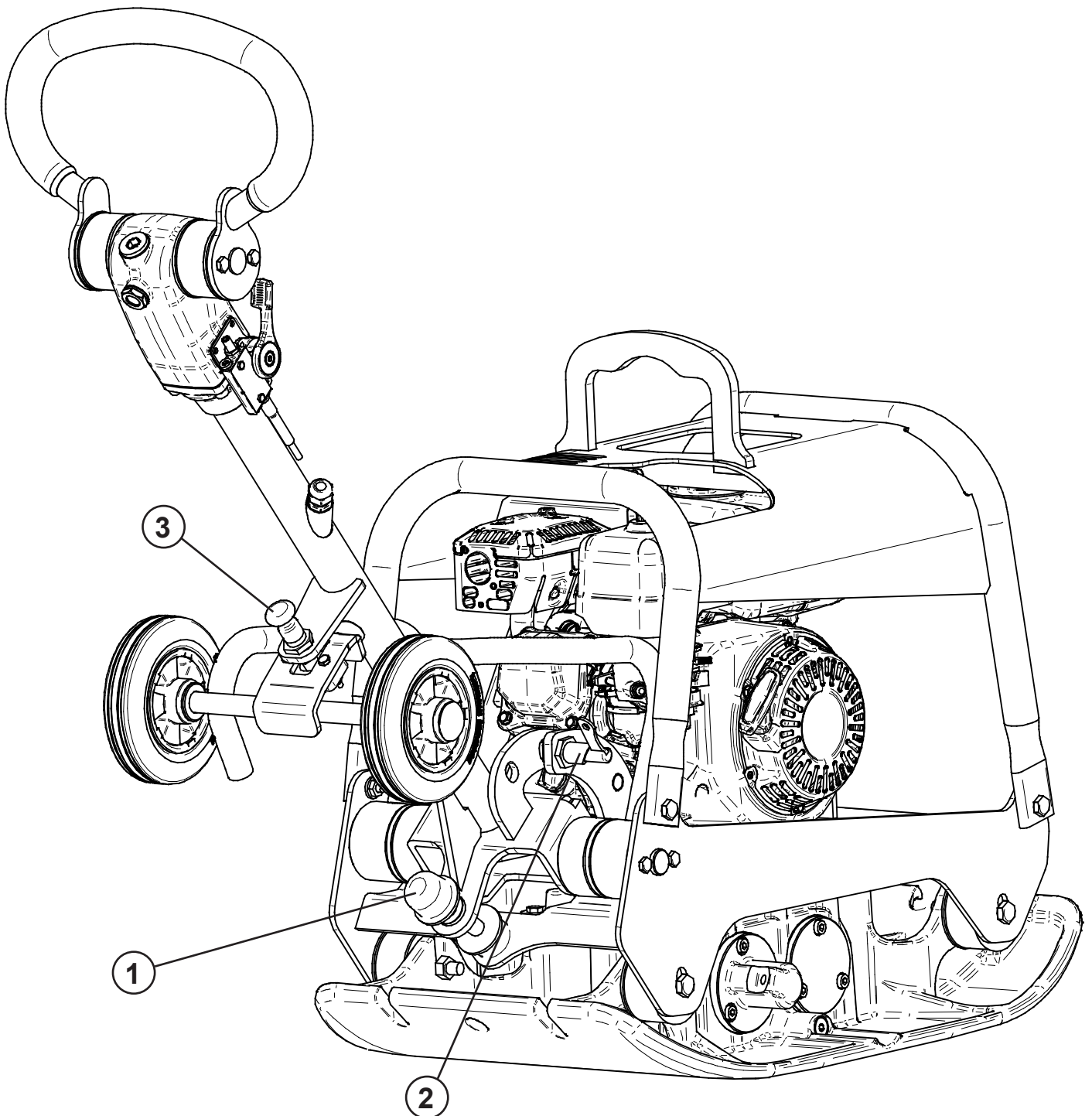

## Working with the machine

### Starting the engine

#### **ATTENTION**

Risk of engine damage. The use of starter spray may lead to overheating in the combustion chamber.

- ▶ Do not use any starter spray.

#### **▲ WARNING**

Danger of suffocation from engine exhausts when starting the engine in closed rooms or poorly ventilated work areas.

- ▶ Start the engine only in well-ventilated environments.
- ▶ See section "Safety" for operating the machine in trenches.

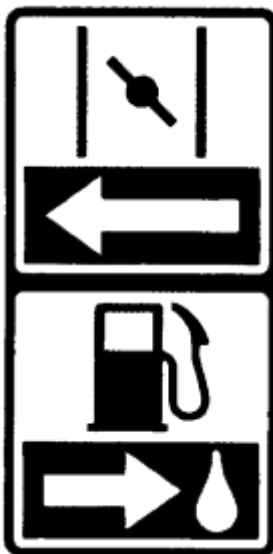

- ▶ Adjust the desired work height of the guide bar with the set screw (1).
- ▶ Set the short-circuit switch (9) to "I".
- ▶ Open the fuel cock (slide to the right).
- ▶ Close the choke lever (slide to the left).
- ▶ Bring the gas lever into the full-throttle position.
- ▶ Slowly pull the handle of the reversing starter until resistance (the compression of the engine) is noticeable.
- ▶ Allow the handle to glide back into the initial position.
- ▶ Pull the handle through quickly, forcefully and completely.
- ▶ Repeat the process if the engine does not start.
- ▶ Set the gas lever to idle speed.
- ▶ Allow the engine to warm up for a few minutes.
- ▶ Open the choke lever (slide to the right).
- ✓ The machine is ready for operation.



## Compacting

### ⚠ CAUTION

There is a crushing hazard between the machine and the wall during work in close proximity to walls.

- ▶ Use extra caution when working close to obstacles

### ⚠ CAUTION

Risk of injury if the machine is guided improperly.

- ▶ Guide the machine safely with both hands on the handle.

### ⚠ ATTENTION

Danger of material damage or excessive wear if V-belt slips through.

- ▶ Operate the machine only in full-throttle mode.

- ▶ Start the engine.
- ▶ Bring the gas lever into the full-throttle position.
- ▶ Switch between forward and reverse travel by setting the handle to the corresponding direction.

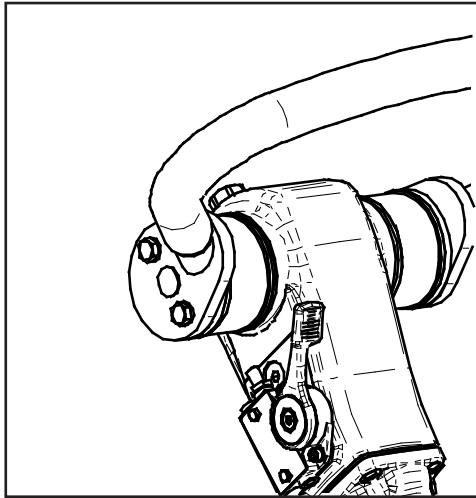

The forward and reverse travel of the machine is infinitely variable.  
The speed of the machine is selected with the corresponding deflection of the handle.

## Switching off the engine

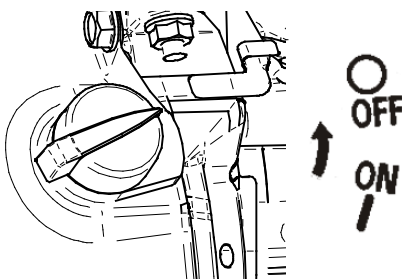

- ▶ Bring the gas lever into the idle speed position.
- ▶ Close the fuel cock (slide to the left).
- ▶ Set the short-circuit switch to "0".

## 6. Transport

### Lifting the machine

The machine can be lifted for loading onto a vehicle.

#### CAUTION

Risk of material damage and injuries. The use of defective or unsuitable lifting gear may cause the machine to fall down.

- ▶ Use slings that possess the appropriate carrying capacity.
- ▶ Lock the guide bar in place in the folded position.
- ▶ Fit the crane hook into the lifting ring and lift the machine up straight.

## 7. Storage

### Storage at the construction site

If stored at the construction site, e.g. over night, the machine must be secured against theft and unauthorized use.

Parked machines presenting an obstacle must be secured in accordance with statutory regulations, particularly in the area of public traffic surfaces.

### Storage for an extended period

If the machine will not be used for a period longer than one month, the following measures must be taken:

- ▶ Clean the entire machine thoroughly.
- ▶ Check the entire machine for leaks. Correct any detected defects.
- ▶ Empty fuel and fill the tank with clean fuel.
- ▶ Check and, if necessary, correct the engine oil level.
- ▶ Check and clean air and fuel filter. Replace if damaged.
- ▶ Lightly oil all bare parts, levers and accelerator control cables.



If the machine is to be stored for longer than six months, contact the Weber MT's service organization to discuss additional measures.

## 8. Maintenance

### General information

The section below contains instructions that need to be observed for regular maintenance. Read these instructions carefully and follow them in order to prevent downtimes of the machine caused by excessive wear or damage to the machine. Also read the safety instructions relevant to machine maintenance before you begin with the maintenance work. They help minimize the risk to maintenance personnel.

### Maintenance personnel

Maintenance and repairs require specific qualifications. These operations may only be carried out by trained professionals. Maintenance personnel must be instructed on how to operate the machine by the owner or by the owner's assigned personnel.

Maintenance personnel are required to wear the personal protective equipment during work (see section "Safety").

### Safety

There is an increased risk of injury during maintenance and repairs, e.g. crushing at moving parts.

Following the conclusion of all maintenance and repairs, all protective fixtures must be refitted and placed back into operation.

Discharged operating fluids have a negative impact on the environment. They must be collected and stored in suitable containers. Disposal in accordance with environmental protection regulations.

All maintenance work may only be carried out when the engine is cold. Safeguard the engine against unauthorized start attempts.

Before starting the machine after maintenance operations, make sure that all loose parts (screws, tool, etc.) have been removed from the machine. They may be drawn in or flung off by moving parts.

Keep the entire machine clean. The stickers must always be clearly legible. Damaged stickers must be replaced.

## 8.1. Maintenance overview

| Activity  | Frequency   |                                  |   |   | See section        |
|---|---|----------------------------------|---|---|--------------------|
|   | Initial maintenance/<br>after 10 operating<br>hours | Every 8 operating<br>hours/daily | Every 50 operating<br>hours/every six<br>months | Every 150 operating<br>hours/every year |                    |
| Change the engine oil                                   | X   |                                  |   | X                                       | 8.2.2              |
| Check the valve play of the engine, adjust if necessary |   |                                  |   | X                                       | Honda instructions |
| Re-tighten all accessible threaded connections          | X   |                                  |   |   |                    |
| Clean the air filter                                    |   | X                                |   |   | 8.2.3              |
| Change the fuel filter                                  |   |                                  | X   |   | Honda instructions |
| Check the oil level of the transmission                 | X   |                                  |   | X                                       | 8.2.4              |
| Change the oil in the exciter                           |   |                                  |   | X                                       | 8.2.5              |



The regulations and the operating and maintenance manuals of the engine manufacturer must be complied with in addition to the activities specified in the above maintenance overview.

## 8.2. Description of the maintenance operations

### **▲ WARNING**

If lubricating oils and fuel come into contact with skin, they can cause skin cancer.

- ▶ Wear protective gloves.
- ▶ If skin contact has occurred, wash the affected areas thoroughly.

### 8.2.1. Check the engine oil level

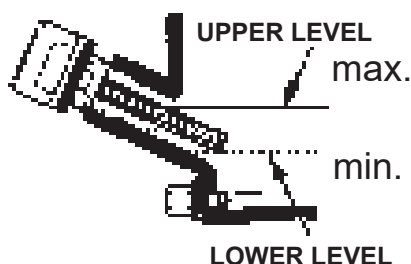
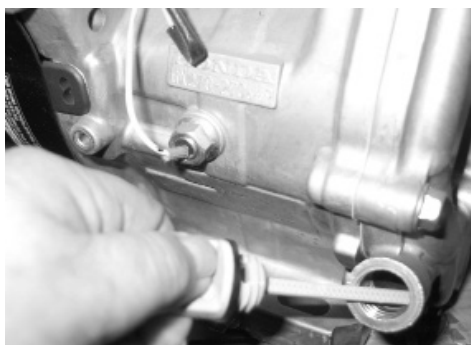

- ▶ Park the machine on a horizontal subsurface.
- ▶ Switch off the engine and wait for several minutes until the oil has collected in the crankcase.

- ▶ Unscrew the oil dip stick from the crankcase.
- ▶ Wipe off the oil dip stick with a clean cloth.
- ▶ Insert the oil dip stick in the oil filler neck as shown, but do not screw it in.
- ▶ Pull out and read the oil dip stick; the correct oil level ranges between the upper level (max) and the lower level (min).
- ▶ Screw the oil dip stick back into the oil filler neck.

### 8.2.2. Change the engine oil

### **▲ CAUTION**

Danger of burn injuries at the hot engine and its attachments.



- ▶ Allow the combustion engine to cool down sufficiently before starting work.
- ▶ Use extra caution during work on the engine when it is at operating temperature.
- ▶ Start the engine and allow the engine to warm up for a few minutes.
- ▶ Switch off the engine.
- ▶ Unscrew the oil dip stick. It also serves as the seal for the oil filler neck.
- ▶ Place a suitable collection vessel under the oil drain.

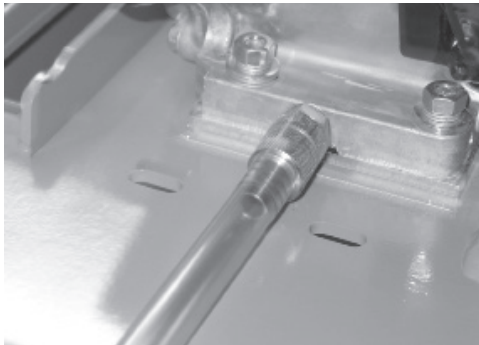

- ▶ Remove the cover cap from the oil drain valve
- ▶ Screw the oil drain hose onto the oil drain valve.

▲ CAUTION! Danger of scalding due to hot oil.

- ▶ Wear protective gloves.
- ▶ Use extra caution.
- ▶ Allow the oil to drain into the collection vessel.
- ▶ Unscrew the oil drain pipe.
- ▶ Attach the cover cap to the oil drain valve.
- ▶ Fill fresh oil into the engine in accordance with the specification.
- ▶ Check the oil level and top off to the “max.” mark.
- ▶ Screw in the oil dip stick.

### 8.2.3. Clean the air filter



- ▶ Open the air filter cover. Loosen the wing nut to do so.
- ▶ Remove the air filter insert. Loosen the wing nut to do so.
- ▶ Separate the non-woven material from the air filter insert.
- ▶ Blow out the non-woven material and the air filter insert from the inside to the outside.
- ▶ Check for damage. Use a new air filter insert in case of damage or excessive clogging.
- ▶ Pull the non-woven material over the air filter insert.
- ▶ Install the air filter insert using the corresponding wing nut.
- ▶ Install the air filter cover using the corresponding wing nut.



#### 8.2.4. Check the hydraulic oil level

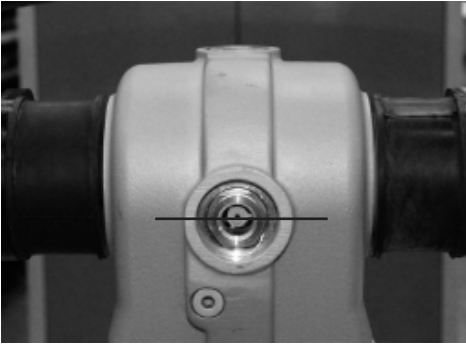

- ▶ Lock the guide bar in place in the transport position.
- ▶ Check the hydraulic oil level.  
The oil level is correct when the oil is in the middle of the view glass.

#### 8.2.5. Change the oil in the exciter

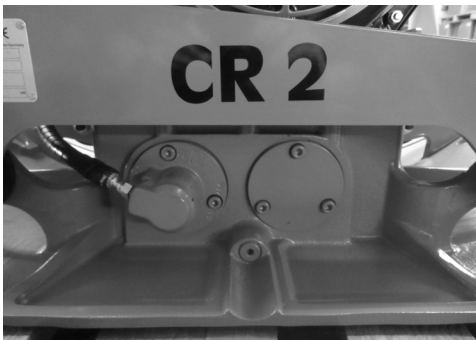

- ▶ Start the engine and allow the engine to warm up for a few minutes.
- ▶ Switch off the engine.
- ▶ Tilt the machine slightly.
- ▶ Place a suitable collection vessel under the machine.
- ▶ Loosen the oil drain plug.
- ▶ Allow the oil to drain.
- ▶ Tilt the machine in the other direction.
- ▶ Fill fresh oil into the exciter in accordance with the specification.
- ▶ Close the oil drain plug.

#### 8.2.6. Check V-belt



- ▶ Shut down the machine.
- ▶ Remove the V-belt guard (1).

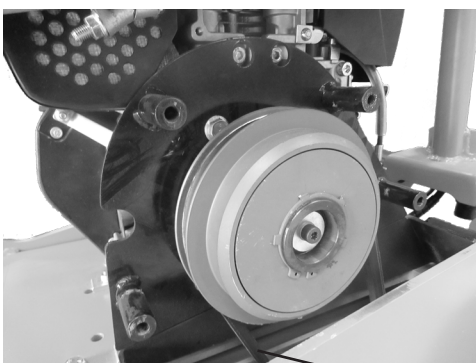

- ▶ Check the V-belt (2) for cracks and wear.
- ▶ Replace the V-belt if it shows signs of extensive wear or other damage.
- ▶ Fit the V-belt guard.

### 8.2.7. Adjust/replace the spark plug

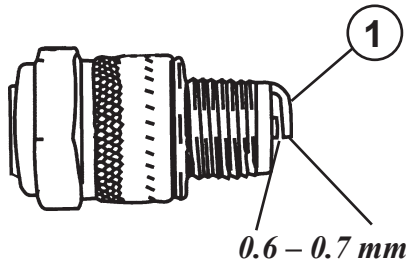

#### **▲ CAUTION**

Danger of burn injuries at the hot engine and its attachments.

- ▶ Allow the combustion engine to cool down sufficiently before starting work.
- ▶ Use extra caution during work on the engine when it is at operating temperature.
- ▶ Pull off the spark plug connector.
- ▶ Unscrew the spark plug.
- ▶ Clean the electrode (1) of the spark plug.
- ▶ Measure the electrode air gap; it must be  $0.6 - 0.7 \text{ mm}$ .
- ▶ If necessary, correct the electrode air gap or replace the spark plug.



### 8.3. Operating fluids and fill levels

| Assembly                    | Operating material  | Quantity     |
|-----------------------------|---|--------------|
|                             | Summer Winter<br>Quality  |              |
| <b>Engine</b><br>Engine oil | SAE 10 W 40<br>(-10 ~ +50 °C)<br>API – CD CE-CF-CG<br>or SHPD<br>or CCMC – D4 – D5 – PD2                    | 0.6 l        |
| <b>Fuel tank</b>            | <b>Unleaded gasoline</b>  | 3.1 l        |
| <b>Vibrator</b>             | Fully-synthetic transmission fluid<br>API GL-5/GL-4<br>First filling Fuchs Titan SINTOPOID<br>LS SAE 75W-90 | 0.5 l        |
| <b>Gearshift</b>            | Transmission fluid<br>DEXRON II-D-ATF<br>First filling<br>Fuchs Titan ATF 3000<br>or equivalent             | As necessary |







[facebook.com/WeberMT](https://facebook.com/WeberMT)



[youtube.com/MyWeberMT](https://youtube.com/MyWeberMT)



**Weber Maschinenteknik GmbH**

Im Boden 5–8, 10 · 57334 Bad Laasphe · Germany  
Phone +49 2754 398 0 · Fax +49 2754 398 101  
[info@webermt.de](mailto:info@webermt.de) · [www.webermt.de](http://www.webermt.de)

085101053-104/CR 2 Hd\_2020-10  
Original operating manual