

Honda E

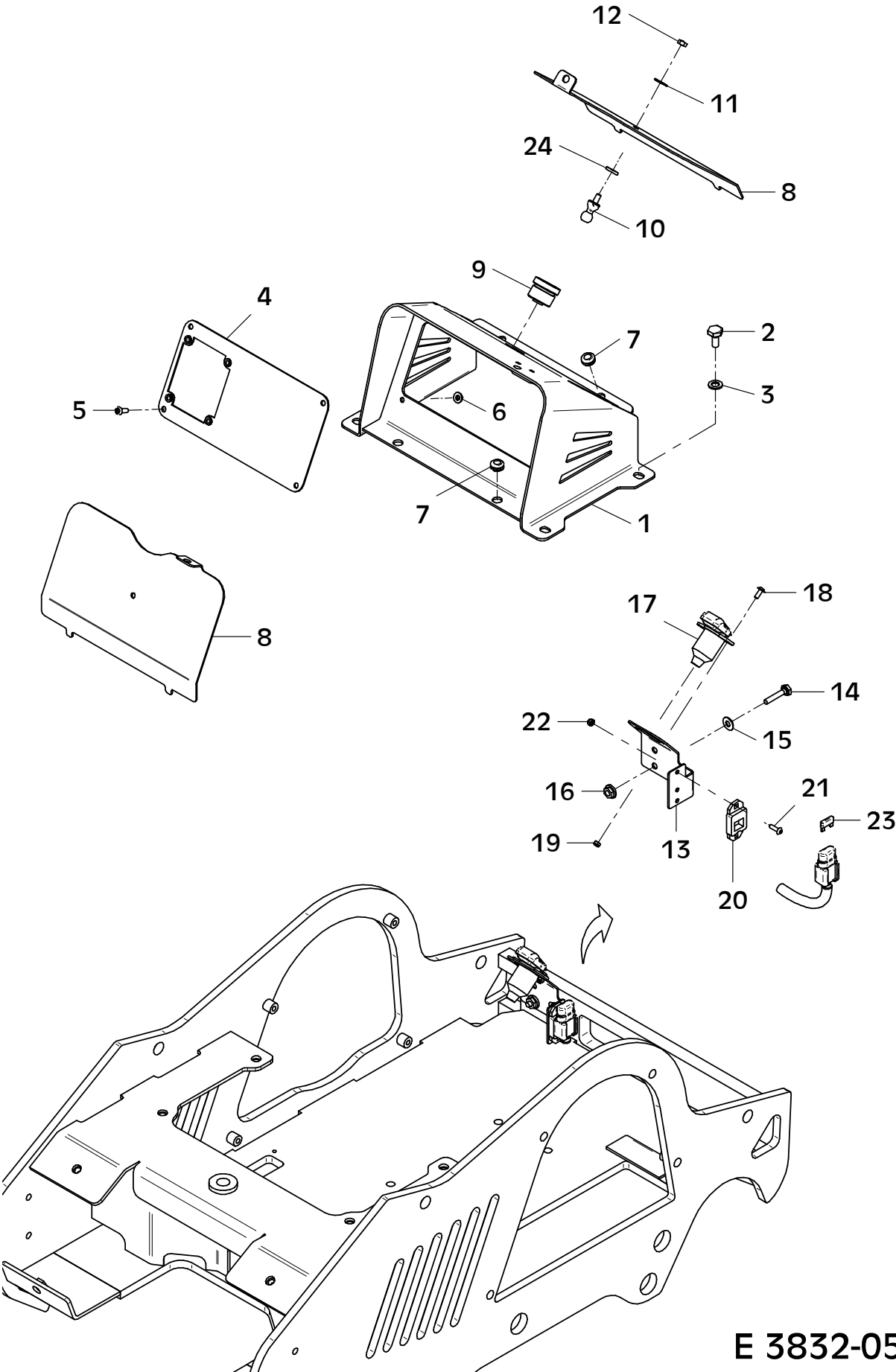

E 3832-0520

E 3832-0520

Position Ref.No. Repère Posizione Posicion	Menge Quantity Quantité Quantita Cantidad	Teile-Nr. Part-No. No. Référence Nr. d'Ordine No. Referenzia	Hinweis Hints Indications Indicazione Indicaciones	Position Ref. No. Repère Posizione Posicion	Menge Quantity Quantité Quantita Cantidad	Teile-Nr. Part-No. No. Référence Nr. d'Ordine No. Referenzia	Hinweis Hints Indications Indicazione Indicaciones
1	1	11002379					
2	4	25038013	DIN933-M10x20				
3	4	20029033	SKM 10				
4	1	11001918					
5	4	25033029	ISO7380-M6x16-10.9				
6	4	20022001	Tensilock M6				
7	4	20025576					
8	1	11001688					
9	1	21000604					
10	1	21000605					
11	1	20029020	SKB 6				
12	1	25031002	DIN934-M6				
13	1	11002378					
14	2	25038010	DIN933-M8x35				
15	2	20029031	SKM 8				
16	2	20022002	Tensilock M8				
17	1	21000590					
18	2	21000647	ISO7380-M5x12-10.9				
19	2	25031023	DIN985-M5				
20	1	20031532					
21	2	21000648	ISO7380-M5x16-10.9				
22	2	25031023	DIN985-M5				
23	1	20031526	10 A				
24	1	25049034	DIN7349-6,4				