

Operating and Maintenance Manual



IVURplus 40 D
IVURplus 50 D
IVURplus 58 D

0242602
0243602
0244602

Table of contents

Introduction	4
General safety guidelines	5
Graphic presentation	9
Technical data	10
Transport	12
Activities prior to starting work	12
Electrical connection	12
Connecting the interior concrete vibrator to the converter	12
Initial operation	13
Shutdown	13
Maintenance	14
Troubleshooting	14
Circuit diagram	16

Introduction

This operating and maintenance manual is designed to facilitate familiarization with your interior concrete vibrator, and enable you to maintain the interior concrete vibrator and use it in accordance with the proper application possibilities.

When complying with the instructions in the operating and maintenance manual you help avoid hazards, reduce repair and downtime costs, and increase the reliability and service life of your interior concrete vibrator.

This operating and maintenance manual must always be available at the implementation site of the interior concrete vibrator.

If necessary you can obtain additional information from your authorized WEBER dealer, or you can obtain information from one of the contact addresses on the last page.

The valid conformity declaration is enclosed with every machine delivery.

You can obtain the current spare parts list of the machine in the WeberMT Service App or use the link below:

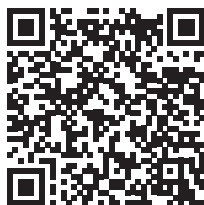

<https://www.webermt.com/DE/deu/ersatzteillistenspare-parts-iv-ivur-mvx/ivur/>

Safety and operating instructions

General

All safety instructions must be read and complied with, non-compliance results in

- danger to life and limb of the user
- impairments to the machine or other property.

In addition to the operating manual, the accident-prevention regulations in the country where the appliance is used must be complied with.

Intended use

Interior concrete vibrators should only be used if in a technically faultless condition, as intended, in a safety-conscious and hazard-conscious manner, and in compliance with the instructions in the operating manual. Malfunctions that impair safety must be eliminated without delay.

The IVUR interior concrete vibrator is designed exclusively for compacting

- concrete.

Any other use of the interior concrete vibrator is considered to be improper use for which the owner shall be exclusively responsible. All liability is rejected if damage occurs due to non-compliance with this provision. This risk is borne solely by the user.

Easily foreseeable misuse

Any use for which the machine is not intended.

Operation

Interior concrete vibrators are only permitted to be operated by suitable persons of or above the age of 18. Operators must be instructed on how to guide the interior concrete vibrator by the owner or by the owner's assigned personnel.

If instructions that affect safety are given by third parties, then the operator must be authorized to reject these instructions.



Unauthorized persons are forbidden from being in the area of the interior concrete vibrator during the compacting process.

Electrical voltage safety

It is prohibited to switch the interior concrete vibrator on or off by removing or inserting the connector plug into or from the power outlet.

The connecting cable of the interior concrete vibrator must not be used to pull the plug out of the power outlet.

Protect electric cables against heat, oil and sharp edges.

Connect IVUR interior concrete vibrators only to the voltage supply specified on the rating plate.

Do not operate IVUR interior concrete vibrators without a grounding conductor. It must be ensured that the power distribution on site is equipped with a suitable ground fault circuit interrupter.

If operating outside of the cooling medium concrete, interior concrete vibrators must be shut down immediately.

When taking a break, shut off the interior concrete vibrator and set it down in such a way that it cannot roll away or fall down inadvertently.



Operating the interior concrete vibrator in an explosive atmosphere is prohibited.



Do not open IVUR interior concrete vibrators until 2 minutes have passed since pulling the plug out of the power outlet as the capacitors built into the converter section require this amount of time to discharge.



According to VDE regulation 0100/part 410, HD 384.4.41 and EC publication 384.4.41 electronic power sources are equated to safety isolating transformers, if the cutoff in the event of a ground fault occurs within less than 0.2 seconds and provided the cutoff is triggered electronically within the system rather than by a mechanical switch.

Behavior if there are defects

If you notice defects on the safety devices or other defects that impair the safe operation of the device, notify your supervisor without delay and suspend operation immediately.

We do not accept any liability in case of non-compliance.

Protective equipment

This machine is capable of exceeding the permissible sound level of 80 dB(A). The owner might also face additional dangers when using the machine. Precautionary action must, therefore, be taken.

Protective equipment includes:



Hearing protection



Hard hat



Safety shoes



Protective gloves





Operation

Prior to starting work the owner of the interior concrete vibrator must be familiar with the work environment. The working environment includes obstacles in the work and traffic area, the bearing capacity of the ground, as well as the necessary safeguarding of the construction site.

The interior concrete vibrator should only be operated when the protective fixtures are mounted. The protective fixtures must all be in functional condition.

At least once per shift the interior concrete vibrator must be checked for apparent defects. If there are apparent defects then operation of the interior concrete vibrator must be stopped immediately and the responsible person must be informed. Prior to restarting, malfunctions of the interior concrete vibrator that have occurred must be corrected.

Maintenance

-  The power plug of the interior concrete vibrator must be unplugged prior to any repair work.
-  Repair work on electrical components may only be performed by a skilled worker.
-  When the repair work is complete, all protective fixtures must be reattached.
-  Discharged operating fluids must be collected and stored in suitable containers. Discharged fluids must be appropriately disposed of in accordance with environmental protection regulations.

Changes and conversions

For safety reasons, do not make any unauthorized changes or conversions to the interior concrete vibrator. The manufacturer expressly excludes any liability for damage that occurs due to changes or conversions to the interior concrete vibrator. To ensure safe and reliable operation, only use original WEBER spare parts.

Inspection

Have internal concrete vibrators inspected for operationally safe status in accordance with the regulations applicable in the country of use at least every 6 months or more frequently if necessary.

The protective conductor current measured for the device may exceed 3.5 mA. A protective conductor current of up to 4 mA is typical.

The insulation resistance is $<1 \text{ M}\Omega$ owing to the integrated protective conductor monitoring of the device. The typical value is $0.24 \text{ M}\Omega$.

Cleaning work

Cleaning tasks should only be executed in areas that are suitable and have been approved for this purpose (oil separator amongst others).

Disposal

All operating fluids and auxiliary materials must be disposed of in an environmentally-compatible manner in accordance with country-specific regulations.

Important information for operating and maintenance personnel is marked by pictograms.



Warning against irritants or materials hazardous to health



Warning against a hazardous place



Warning against a suspended load



Wear ear protection



General regulation



Environmental protection



Hard hat



Safety shoes



Protective gloves

Graphic presentation

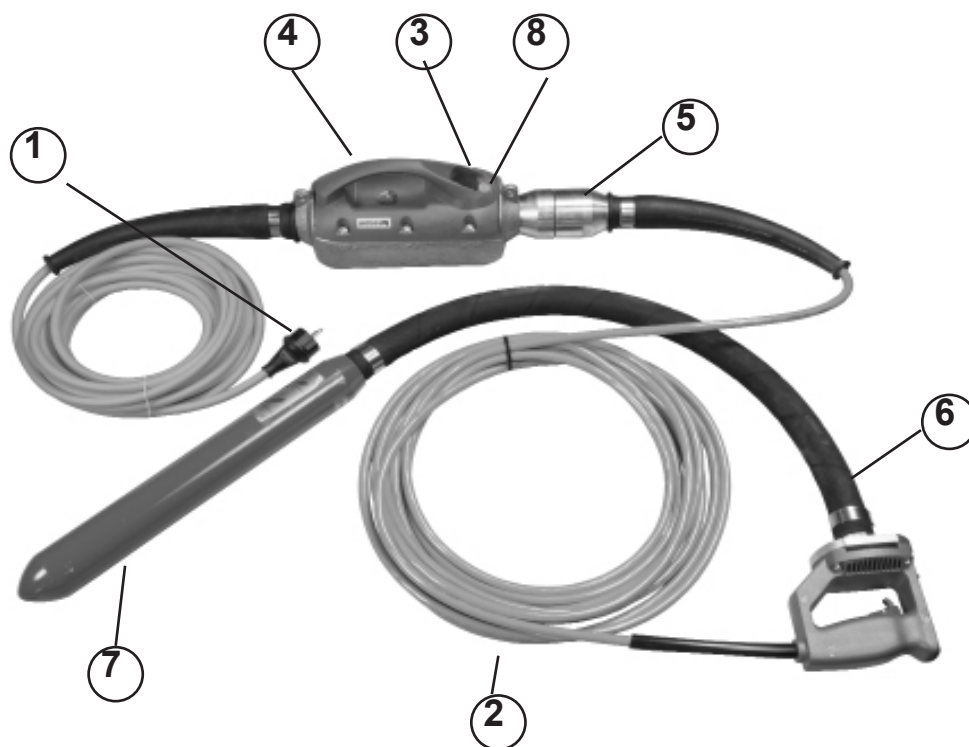

Overall view IVURplus 40 D/50 D/58 D

- 1 Plug
- 2 Connecting cable
- 3 Switch
- 4 Converter
- 5 Coupling
- 6 Protective tube shielded in accordance with "EMC Directive"
- 7 Interior concrete vibrator
- 8 LED protective conductor system

Technical data

		IVUR 40	IVUR 50	IVUR 58
Weight				
Operating weight CECE (in kg)		14	16	17
Effective diameter approx. mm		400	500	600
Dimensions				
Vibrator diameter	mm	40	50	58
Vibrator length	mm	330	370	420
Protective tube length	mm	5000	5000	5000
Weight	kg	7.5	9.5	10.5
Connection vibrator section				
Input voltage	(V)	220	220	220
Rated current	(A)	1.8	2.6	3
Frequency	(Hz)	200	200	200
Rated power	(W)	650	850	1050
Connection converter section				
Voltage	(V)	230	230	230
Frequency	(Hz)	50	50	50
Rated current	(A)	4.6	4.6	4.6
Rated power	(kVA)	1.6	1.6	1.6
Connecting cable	(m)	10	10	10
Degree of protection		IP 67	IP 67	IP 67

	IVUR 40	IVUR 50	IVUR 58
Noise and vibration values			
Sound pressure level LPA (at the operating station in accordance with 2000/14/EC, in dB(A))	72	78	81
Hand/arm vibration (effective weighted value of the acceleration on the guide handle, determined in accordance with 2006/42/EC, Part 1, in m/s ²)	0.7	2.2	2.7

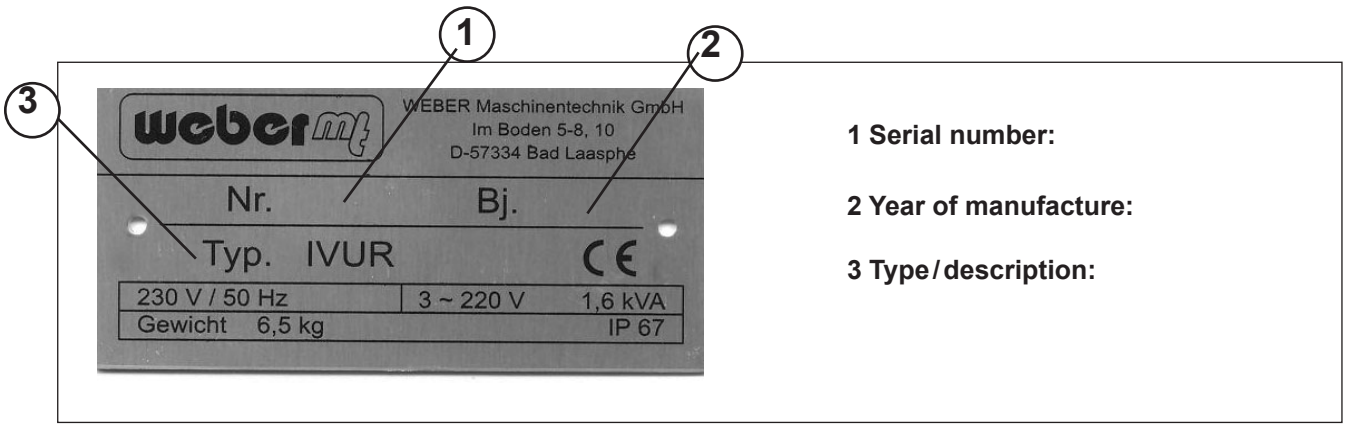

1 Serial number:

2 Year of manufacture:

3 Type/description:

Transport

When transported on vehicles, the interior concrete vibrator must be secured against slipping or rolling away using suitable means.

Activities prior to starting work electrical connection

 Before putting the interior concrete vibrator into operation, make sure the mains voltage (1) corresponds to the voltage specified on the rating plate.

The connection must be made to a 230 Volt/50 Hz AC power source.

 The power source is only suitable if its input voltage does not deviate from the rated voltage by more than 15 %.

 Operate only with an approved ground fault circuit interrupter.

 Damages resulting from non-compliance will void any warranty claims.

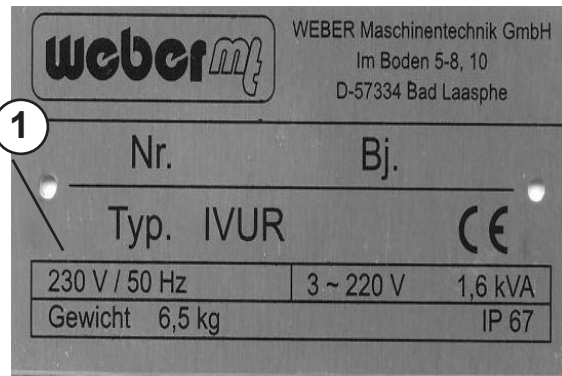

Connecting the interior concrete vibrator to the converter

 The interior concrete vibrator must not be connected to the converter unless the power plug has been unplugged.

 Clean connecting threads (4) and (6) before connecting the interior concrete vibrator to the converter.

 Lightly oil the connecting thread (4) on the converter (3).

Start by inserting the plug (1) with the grounding conductor (2) into the coupling (3).

 Make sure that current can pass through the grounding conductor (2).

Firmly tighten the converter (1) by screwing down the coupling (2).

 It is also possible to use IVU 40/IVU 50/IVU 58 interior concrete vibrators.

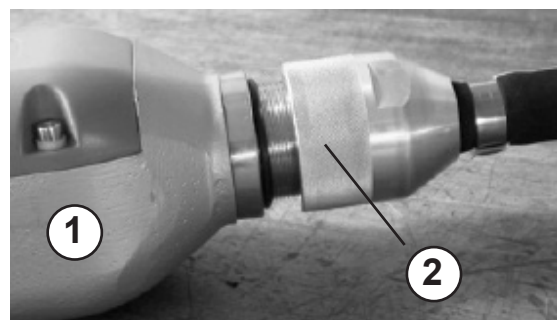
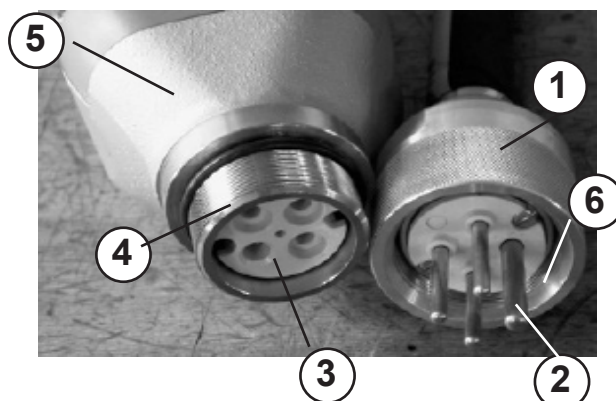

Initial operation

Connect the interior concrete vibrator only to a voltage supply that corresponds to the voltage specified on the rating plate.

- ⚠ Always insert the power plug into the power outlet before switching on the converter.

Insert the power plug (1).

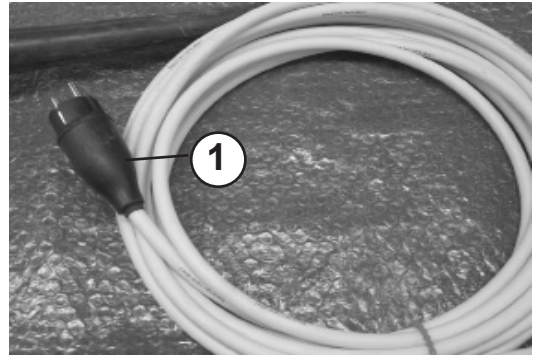

Put the converter into operation by pressing the switch (1).



Switch on the interior concrete vibrator by pressing the switch (1). The interior concrete vibrator starts up.

- ⚠ If this is not the case, shut down the interior concrete vibrator immediately and determine the fault.

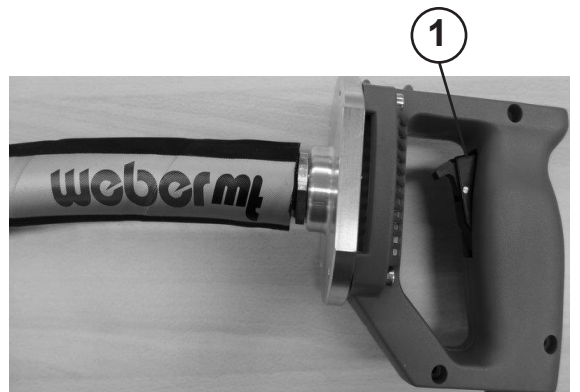

Shutdown

Shut down interior concrete vibrator and converter by pressing the switch (1).
Pull the plug out of the power outlet.

- ⚠ Do not pull on the cable to remove the plug of the interior concrete vibrator from the power outlet.

Maintenance

Maintenance interval	Maintenance point	Maintenance activity
Daily	Entire machine	<ul style="list-style-type: none"> – Clean unit – Check connecting cable and plug for exterior damage
Every 200 operating hours		<ul style="list-style-type: none"> – Check bottle neck and bottle tube for wear, replace if necessary

 Work must be carried out using regulation tools, and the operating and maintenance manual must be complied with for all work.

Troubleshooting

Fault	Possible cause	Remedy
Interior concrete vibrator cannot be put into operation	Operating error Grounding conductor faulty	Put the unit into operation as specified in the operating manual
Interior concrete vibrator is without function when switched on	Automatic shutoff Grounding conductor faulty	Shut down interior concrete vibrator and wait approx. 30 s before switching it back on Shut down, correct error
Interior concrete vibrator shuts off during compacting	Automatic shutoff	Do not operate the interior concrete vibrator unless the entire bottle body is covered by concrete

Blink code at converter



The switch housing may only be opened by skilled personnel.



The converter board is live after the removal of the switch housing.

– **Danger to life** –

Cover (1)
Housing (2)
Electronics (3)
LED yellow (4)

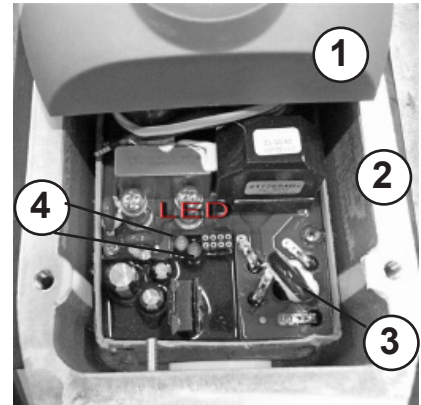

LED display	Cause
Green LED is lit permanently	Converter in operation
Yellow LED flashes 1 x in rapid succession	Ixt surveillance
Yellow LED flashes 2 x in rapid succession	Overcurrent
Yellow LED flashes 3 x in rapid succession	Overtemperature
Yellow LED flashes 6 x in rapid succession	Undercurrent
Yellow LED flashes 7 x in rapid succession	Overload
Yellow LED flashes 9 x in rapid succession	Short circuit

Circuit diagram IVUR

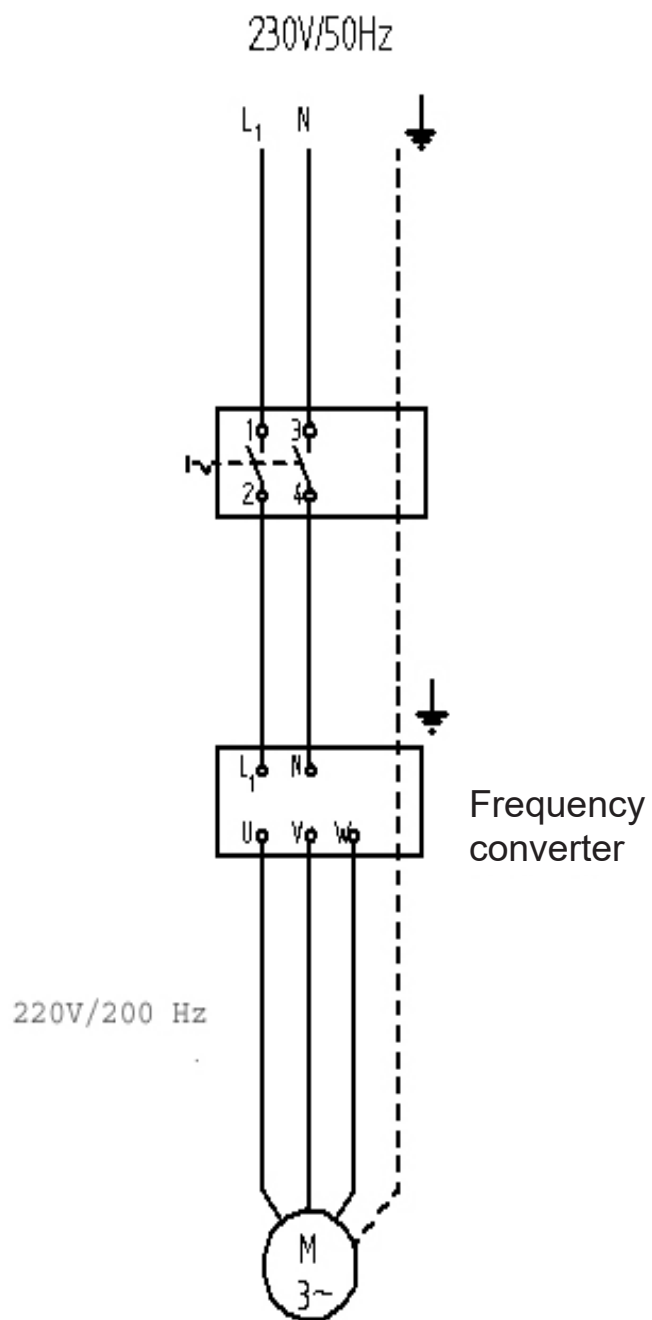



facebook.com/WeberMT



youtube.com/MyWeberMT



Weber Maschinenteknik GmbH

Im Boden 5–8, 10 · 57334 Bad Laasphe · Germany
Telefon +49 2754 398 0 · Fax +49 2754 398 101
info@webermt.de · www.webermt.de