

Operating and Maintenance Manual



1216/englisch/Übersetzung der Original-Betriebsanleitung

SRV Black-Edition

Subaru ER 12



Weber Maschinentechnik GmbH

Im Boden 5 - 8 , 10

D-57334 Bad Laasphe-Rückershausen / Germany

Tel.: + 49 (0) 27 54 / 398 0

Fax: + 49 (0) 27 54 / 398 101

E-Mail: info@webermt.de

Web: www.webermt.de

Table of contents

Introduction	4
Safety guidelines	5
Graphic presentation	8
Device description	9
Technical data	10
Activities prior to starting work	12
Starting	13
Tamping	14
Taking out of operation	14
Maintenance overview	15
Maintenance work	16
Operating fluids and fill levels	20
Troubleshooting	20
Storage	21
Contact addresses	23

Introduction

This operating and maintenance manual is designed to facilitate familiarization with your tamper, and enable you to maintain the tamper and use it in accordance with the proper application possibilities. When complying with the instructions in the operating and maintenance manual you help avoid hazards, reduce repair and downtime costs, and increase the reliability and service life of your tamper.

This operating and maintenance manual must always be available at the implementation site of the tamper.

If necessary you can obtain additional information from your authorized WEBER dealer, or you can obtain information from one of the contact addresses on the last page.

You can obtain information on the assembled Robin-Subaru gasoline engine and find a spare-part list for it at **www.robin-europe.de**

The valid conformity declaration is enclosed with every machine delivery.

Safety guidelines

General

All safety instructions must be read and complied with, non-compliance results in

- Danger to life and limb of the user
- Impairments to the machine or other property.

In addition to the operating manual, the accident-prevention regulations in the country where the appliance is used must be complied with.

Intended use

The tamper should only be used in technically faultless condition, as intended, in a safety-conscious and hazard-conscious manner, in compliance with the instructions in the operating manual.

Malfunions that impair safety must be eliminated without delay.

The SRV Black-Edition tamper is designed exclusively for compacting

- Sand
- Gravel
- Crushed rock
- Semi-cohesive mixed material

Any other use of the tamper is considered to be improper use for which the owner shall be exclusively responsible. All liability is rejected if damage occurs due to non-compliance with this provision. This risk is borne solely by the user.

Easily foreseeable misuse

Any use for which the machine is not intended.

Operating

Tampers should only be operated by suitable personnel of at least 18 years of age. Operators must be instructed in how to guide the tamper by the owner or by owner's assigned personnel.

The machine operator must comply with traffic regulations. If instructions that affect safety are given by third parties, then the operator must be authorized to reject these instructions.

Protective equipment

This machine is capable of exceeding the permissible sound level of 80 dB(A). The owner might also face additional dangers when using the machine. Precautionary action must, therefore, be taken.



Unauthorized persons are forbidden from being in the area of the tamper during the compacting process.

Protective equipment includes:



Hearing protection



Hard hat



Safety shoes



Protective gloves

Operation

Prior to starting work the owner of the tamper must be familiar with the work environment. The working environment includes obstacles in the work and traffic area, the bearing capacity of the ground, as well as the necessary safeguarding of the construction site in the area adjacent to public traffic; and it also includes compliance with traffic regulations.

The tamper should only be operated when the protective fixtures are mounted. The protective fixtures must all be in functional condition.

At least once per shift the tamper must be checked for apparent defects. If there are apparent defects then operation of the tamper must be stopped immediately and the responsible person must be informed. Prior to restarting, tamper malfunctions that have occurred must be corrected.

Operation under difficult conditions

 Never inhale the exhaust gas; it contains carbon monoxide, a colorless and odorless gas that is extremely hazardous, which, if inhaled even briefly, can cause unconsciousness and death.

Therefore, never operate the engines in enclosed areas or in areas that are poorly ventilated (tunnels, caves, etc.). Exercise particular caution when operating the engine in the vicinity of people and livestock.

Prior to maintenance and repair work

Only use **original Weber spare parts** for maintenance or repair work to ensure reliable and safe operation.

Adjusting tasks, maintenance tasks, and inspection tasks must be carried out on schedule as specified in this operating and maintenance manual. These activities should only be executed by trained personnel.

For repair, maintenance, or inspection work the engine of the tamper must be safeguarded against unintentional starting.

All pressurized lines, particularly hydraulic lines and lines of the injection system of the drive motor must be depressurized before performing maintenance or repair tasks.

For maintenance and repair tasks the tamper must be placed on a level and stable substrate and must be secured from rolling off or tipping over.

Heavy components and assemblies must be secured to and lifted by hoisting machines that can bear their weight when they are replaced. Ensure that no hazard is caused by raising components or assemblies.

Do not position yourself or work under suspended loads.

 If lubricating oils and fuel come into contact with skin, they can cause skin cancer. Upon contact with the skin, clean affected skin with suitable cleaning agent without delay.

Inspection

Tampers must be inspected in accordance with appropriate implementation conditions and operating conditions, as needed; however an inspection to ensure operationally safe status must be performed by an expert at least once a year. The results of the inspection must be recorded in writing and must be stored at least until the next inspection.

Cleaning work

Prior to cleaning the tamper with a high-pressure cleaner, protect all accessible energized switches, cable connections, etc. against water penetration by masking them off.

Cleaning tasks should only be executed in areas that are suitable and have been approved for this purpose (oil separator amongst others).

Disposal

All operating fluids and auxiliary materials must be disposed of in an environmentally-compatible manner in accordance with country-specific regulations.

Important information for operating and maintenance personnel is marked by pictograms.



Warning against irritants or materials hazardous to health



Warning against a hazardous place



Warning against a suspended load



Wear ear protection



General regulation



Environmental protection



Hard hat



Safety shoes



Protective gloves

Graphic presentation

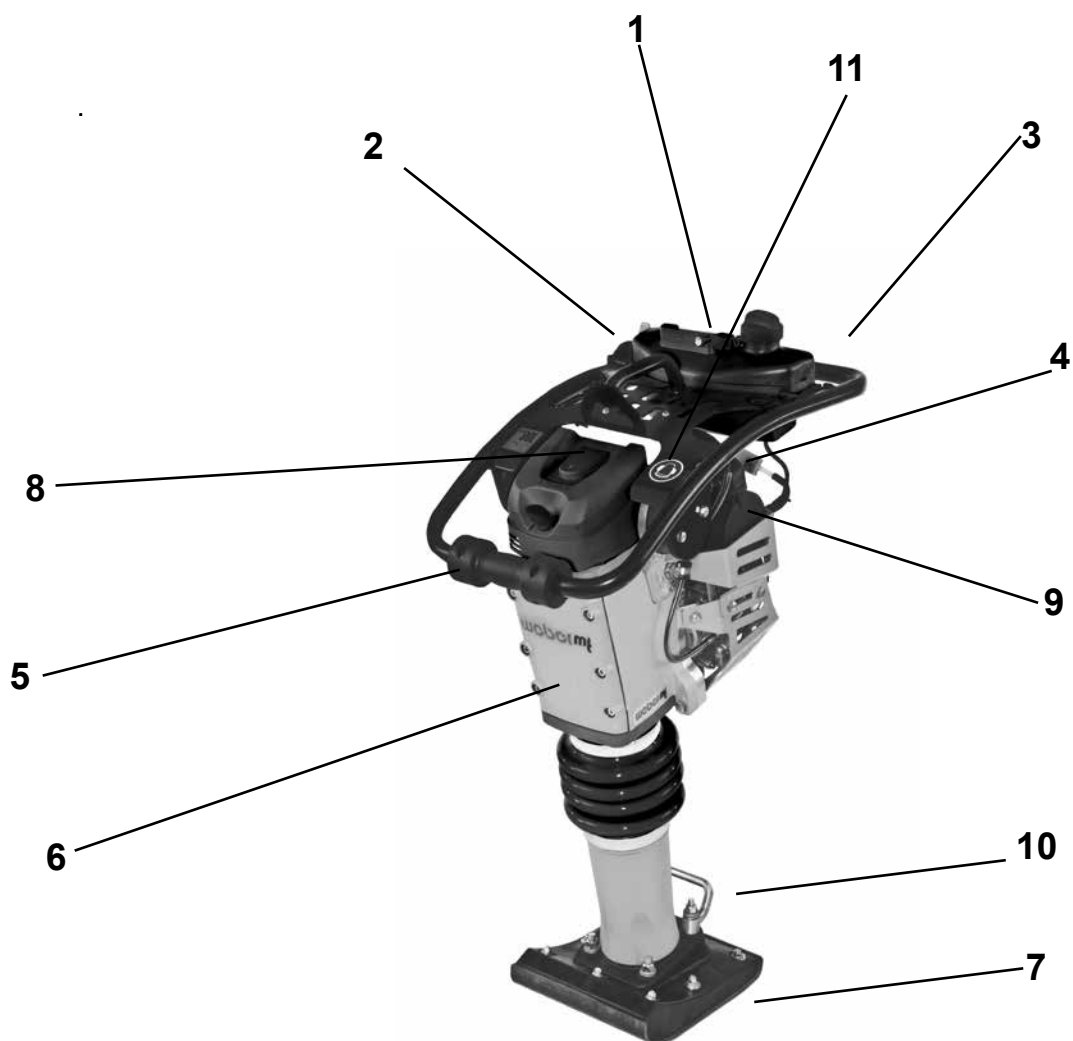

Total overview SRV Black-Edition

1	Fuel tank	6	Tamping system
2	Gas lever	7	Tamping foot
3	Hand guide bracket	8	Main filter
4	Engine	9	Secondary air filter
5	Transport roller	10	Handle
		11	Hearing protection (sticker) 

Device description

The series SRV Black-Editionj tamper is used for road-building, canal construction, pipe laying and landscaping compaction tasks.

Drive

The tamper is powered by an air-cooled Subaru-Robin gasoline engine.

Force is transmitted via the centrifugal clutch directly to the tamping system. The compaction work is performed by the tamping foot.

The engine is protected by a double filter system consisting of an oversized main air filter and an additional air filter.

Operation

Start the Subaru-Robin gasoline engine with the attached reversing starter.

After starting the stamping system starts to vibrate via the centrifugal clutch which is attached to the engine. Use the gas lever to vary the engine speed between idle speed and full-throttle speed.

For easier transport the tamper can be pushed onto or into a means of transport with the help of the transport roller.

Technical data

	SRV Black-Edition
Weight	
Operating weight CECE in kg	70
Dimensions	
Overall length (in mm)	740
Overall width (in mm)	365
Height (in mm)	1035
Tamping foot width (in mm)	280
Impact rate (/min)	670
Stroke (in mm)	77,2
Drive	
Engine manufacturer	Subaru
Type	ER 12
Performance at operating speed in accordance with ISO 3046-1 (kW)	2,7
Combustion process	4-stroke gasoline
Operating speed (1/min)	3900
Fuel	Gasoline unleaded

	SRV Black-Edition
Noise emissions in accordance with 2000/14/EC	
Sound pressure level L_{PA} ascertained in accordance with EN 500, in dB (A)	98
Sound pressure level L_{WA} ascertained in accordance with EN ISO 3744 and EN 500, in dB (A)	108
Vibration values	
Root-mean-square acceleration value for hand-arm vibration ascertained in accordance with EN 500 in m/s^2	10
 In accordance with directive 2006/42/EC, complying with the vibration values is the owner's responsibility.	

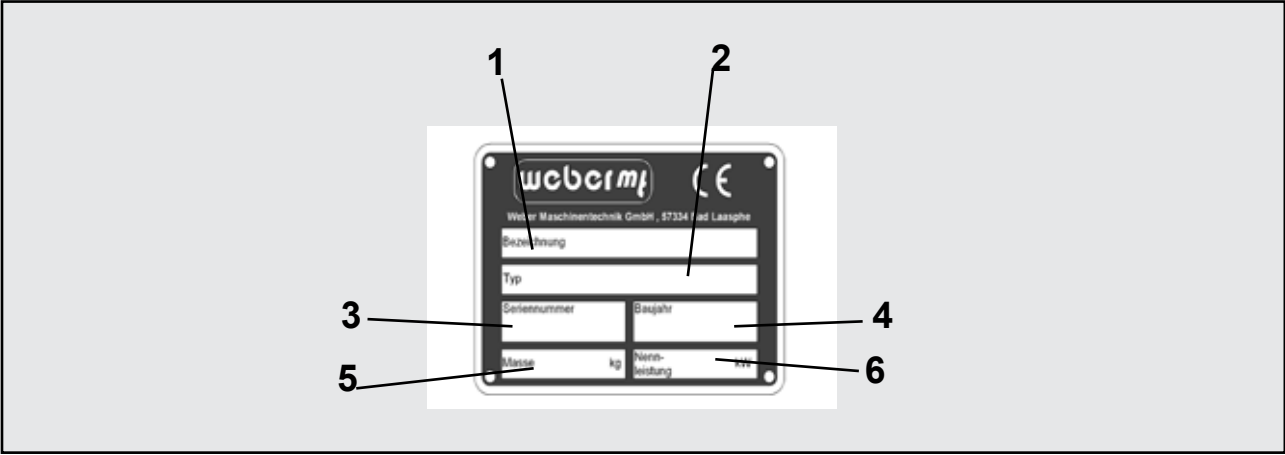

<p>1 Description</p> <p>.....</p>	<p>2 Type</p> <p>.....</p>
<p>3 Serial number</p> <p>.....</p>	<p>4 Year of manufacture</p> <p>.....</p>
<p>5 Weight</p> <p>.....</p>	<p>6 Rated power kW</p> <p>.....</p>

Activities prior to starting work

Transport

 When transporting the tamper on a vehicle, secure it with suitable restraints.

Loading with crane

Fit the crane hook into the lifting ring (1) and lift the machine onto the desired means of transport.

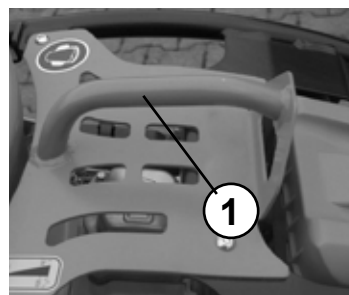

 Only use lifting machines with a minimum bearing capacity of 100 kg.

 Do not step under suspended loads.

Check the engine oil level

Pull the oil dip stick (1) out of the crankcase.

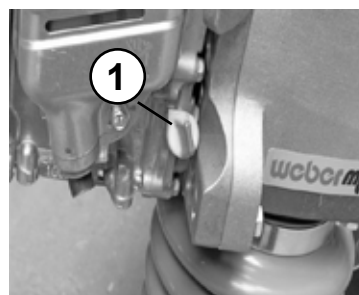

The correct oil level is between the min. and max. marks.

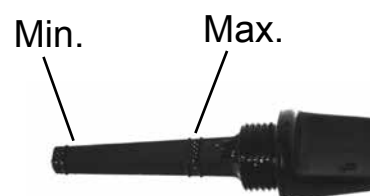



Check the fuel level

Open and remove the gas cap (1), check the level, if necessary top off to the lower edge of the filler neck with clean fuel in accordance with the specification.

 Carefully wipe up spilled fuel.

 If lubricating oils and fuel come into contact with skin, they can cause skin cancer. Upon contact with the skin, clean affected skin with suitable cleaning agent without delay.

 For work at the fuel system, have a suitable fire-extinguishing agent at the ready.

 Fire, naked light, and smoking is forbidden!



Starting

- ⚠ **After horizontal transport: Bring tamper into a vertical position and wait several minutes until the engine oil has collected in the lower area of the crankcase.**

Bring the gas lever into full-throttle lock-in position.

Open the fuel cock (1).

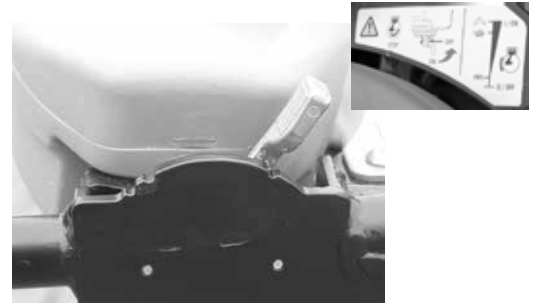

Push the choke lever (1) to the right (close).

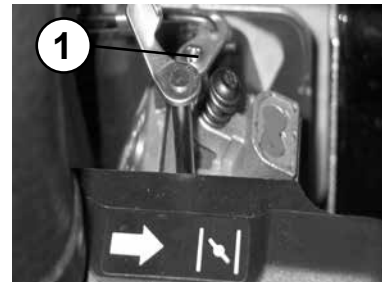

- ⚠ After the engine has warmed up, slide the choke lever to the left (open).

Slowly tighten the handle (1) of the reversing starter (2) until resistance is noticeable. Allow the handle (1) to glide back into the initial position, and then forcefully and completely pull it through with both hands. Allow the engine to warm up for a few minutes.

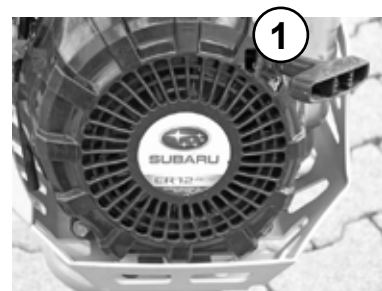

- ⚠ When starting in enclosed spaces ensure adequate ventilation - danger of suffocation.

- ⚠ Never use any starter spray.

Tamping

Bring the gas lever into the lock-in position  / 



 Only run machine within reach of the manual guidance rod (1).

 Compacting is only permissible at full throttle speed as there is an increase level of wear in the slip range of the centrifugal clutch.

 At obstructions (walls, pits, etc.) ensure that no one can be caught between the machine and the obstruction; or ensure that the machine does not slip into the pit.

 Unauthorized persons are forbidden from being in the area of the tamper during the compacting process.

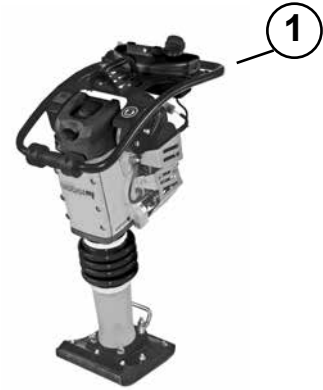

Shutting down

 Do not switch off the engine under full load; let engine run idle for a few minutes.

Bring the gas lever to the „min.“ (1) lock-in position.



Close the fuel cock (1).



To shut off the engine push the gas lever back beyond the idle lock-in setting







 During breaks — even if they are short — the machine must be shut down.

 Parked devices that represent an obstacle must be safeguarded against conspicuously.



Maintenance overview

Maintenance interval	Maintenance point	Maintenance activity
After the first 10 operating hours	Engine	- Change engine oil - Re-tighten all accessible threaded connections
Every 50 operating hours/ every 6 months	Main air filter Engine	- Clean air filter insert, check for damage, replace if necessary - Change engine oil - Clean the engine oil filter - Change the fuel filter
Every 150 operating hours/every year	Tamping system	- Change oil

-  The regulations of the engine manufacturer must be complied with in addition to the above maintenance overview!
-  Work must be carried out using regulation tools and the operating and maintenance manual must be complied with for all work.
-  All maintenance work: Select a collection vessel that is large enough to prevent oil from spilling onto the ground. Dispose of waste oil in an environmentally friendly manner (regulation on waste oils).
-  Dispose of oils, greases, cloths soaked in oil, and replaced parts with oil on them in an environmentally friendly manner.
-  If lubricating oils and fuel come into contact with skin, they can cause skin cancer. Upon contact with the skin, clean affected skin with suitable cleaning agent without delay.
-  If accessible during maintenance, check the condition and stability of all screws.

Maintenance work

Change engine oil

Remove the protection (1).





Remove oil dip stick.

Open the drain plug (1) of the engine and drain oil.

 Only drain engine oil when at operating temperature.

Screw in the oil drain plug (1) with new seal and top off with oil as specified.

 Danger of scalding due to hot oil.

 When working in the area of the engine compartment there is a danger of getting burnt!

 Check the oil fill level with the oil dip stick again.

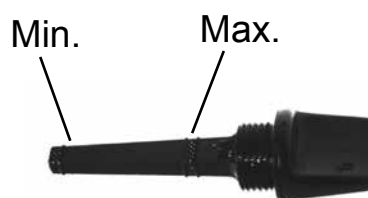
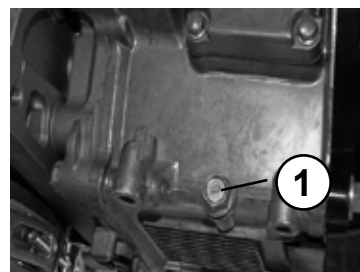

Clean oil screen

Drain oil as described above.

Unscrew the screw (1) including the attached oil screen from the crankcase.

Use white gas to clean the oil screen before reinstalling it in the crankcase.

 Only drain engine oil when at operating temperature.

 Danger of scalding due to hot oil.

 When working in the area of the engine compartment there is a danger of getting burnt!

 Check the oil fill level with the oil dip stick.

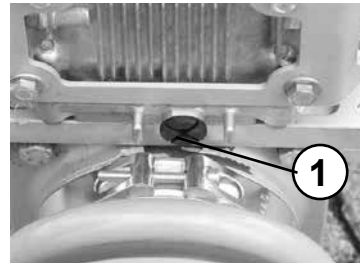

Clean/change main air filter cartridge

Unscrew the air filter cover (1).

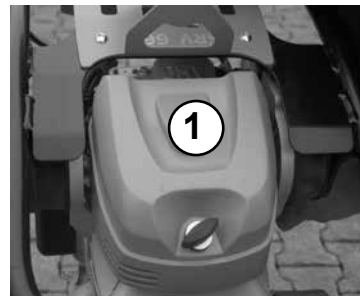

Remove the air filter insert (1) and the air filter fleece (2) from the air filter enclosure or remove air filter cover. Clean air filter insert and air filter fleece as specified by the engine manufacturer if there is damage or if they are extremely dirty.

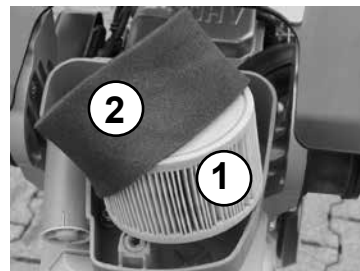

Dispose of oils, greases, cloths soaked in oil, and replaced parts with oil on them in an environmentally friendly manner.



If lubricating oils and fuel come into contact with skin, they can cause skin cancer. Upon contact with the skin, clean affected skin with suitable cleaning agent without delay.

Clean/change secondary air filter cartridge

Remove the protection (1).

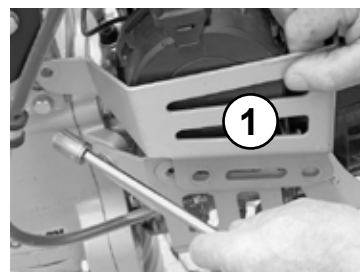

Remove the air filter cover (1).

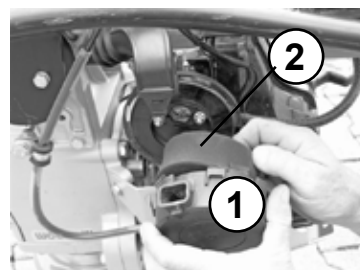

Remove the air filter insert (2) and the air filter fleece from the air filter enclosure or remove air filter cover. Clean air filter insert and air filter fleece as specified by the engine manufacturer, if there is damage or or extreme fouling.

Change the fuel filter

Pull the fuel line (1) off the fuel cock (2).

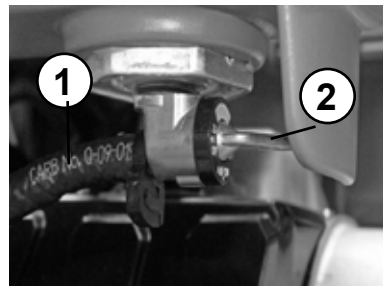

Unscrew the fuel cock, including fuel filter (1) out of the fuel tank.

Clean the fuel filter

 Replace fuel filter if damaged.

 For work at the fuel system, have a suitable fire-extinguishing agent at the ready.

 Fire, naked light, and smoking is forbidden!



Change the fuel line filter

Pull the fuel line (2) off the fuel filter (1) on both sides.
Replace the filter with a new filter element.

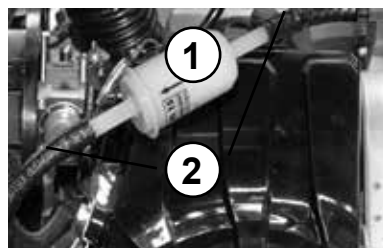

Adjust/replace the spark plug

Pull off the spark plug connector (1) and unscrew spark plug.

Clean the electrode (1) of the spark plug.

Measure the electrode air gap (1), the gap should be 0.6 - 0.7 mm.

Correct the electrode air gap or replace the spark plug if necessary.

 Only use spark plugs with the correct thermal value.

 This work may only be carried out when the engine is cold.

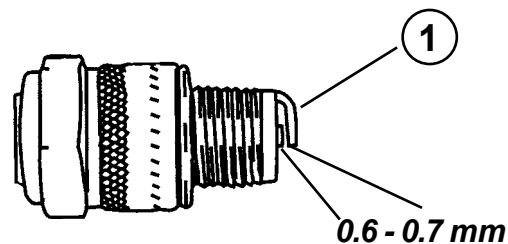
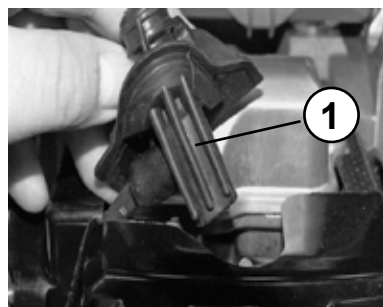

Change the oil in the tamping system

Unscrew the screw plug (1) from the fill opening.

Tilt the tamper forward slightly and let the old oil drain into a suitable collection container. Tilt the tamper back and fill oil in as specified.

Clean the screw plug and screw it into the fill opening.



Select a collection vessel that is large enough to prevent oil from spilling on the ground. Dispose of waste oil in an environmentally friendly manner (regulation on waste oils).

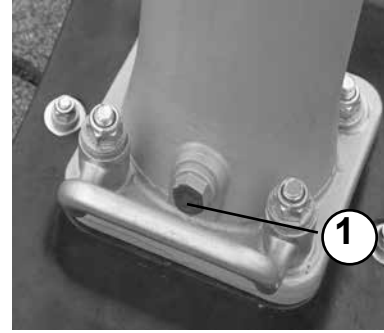

Dispose of oils, oil-soaked cloths, and parts

replaced and smeared with oil in an environmentally friendly manner.

Change the tamping foot

Unscrew the 4 nuts (1).

Lift the tamping foot (2) off of the tamper and attach a new tamping foot.



When mounting the new tamping foot the nuts (1) must be tightened with a torque of 35 Nm.



Mount the fastening nuts of the tamping foot using the plate springs as shown in the adjacent illustration.

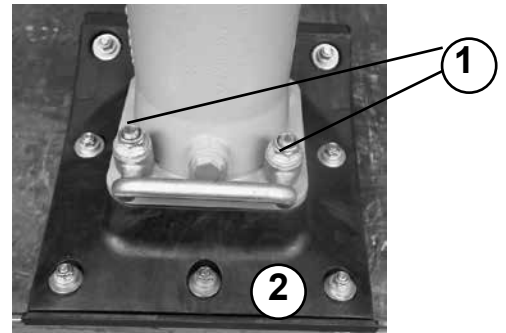

Mounting arrangement of the plate springs

Operating fluids and fill levels

Assembly	Operating material		SRV Black-Edition
	Summer	Winter	
Engine Engine oil	SAE 10 W 40 Quality		0.3 L
Fuel tank Gasoline	Unleaded gasoline		3.0 L
Tamper lower part	Hydraulic oil HVLP 68		1.0 L

Troubleshooting

Fault	Possible cause	Remedy
Tamper does not start	Operating error	Execute the start process as prescribed
	Lack of fuel	Check the fuel level
	Air filter fouled	Clean/change air filter
	Fuel filter fouled	Change the fuel filter
	Spark plug fouled	Clean, adjust, replace the spark plug
Oil level too low	Top off with oil	
Engine runs but it does not reach full speed or engine runs but stops after a short time	The fuel line is incorrectly mounted	Check the mounting of the fuel line
	Air filter fouled	Clean/change air filter
	Fuel filter fouled	Change the fuel filter
	Spark plug fouled	Clean, adjust, replace the spark plug
Fuel cock closed	Open fuel cock	
Engine runs at full rpm, tamper does not tamp or tamps inadequately Unclean compaction pattern	Centrifugal clutch is defective	Repair
	Tamping foot is worn	Change the tamping foot

Action to be take before long-term storage (longer than a month)

Entire soil compactor	<ul style="list-style-type: none"> - Clean thoroughly - Check watertight - If there are leaks, correct defects
Fuel tank	<ul style="list-style-type: none"> - Empty fuel and fill with clean fuel up to the lower edge of filler neck
Engine	<ul style="list-style-type: none"> - Check oil level, if necessary fill to upper oil-level mark - Check air filter, clean, replace if necessary - Check fuel filter, change if necessary
All bare parts/accelerator/accelerator control cable/fastening bolts	<ul style="list-style-type: none"> - Oil/grease

 If the machine is to be stored for longer than six months, then contact the Weber service organization to discuss additional measures.



Weber Maschinentechnik GmbH

For problems, questions and further information refer to one of the following addresses:

in Germany	WEBER Maschinentechnik GmbH Im Boden 5 – 8, 10 57329 Bad Laasphe - Rückershausen	Telefon Telefax E-Mail	+ 49 (0) 2754 - 398-0 + 49 (0) 2754 - 398101-switchboard + 49 (0) 2754 - 398102- spare parts- directlinie g.voelkel@webermt.de
in France	WEBER Technologie SARL 14' rue d' Arsonval 69680 Chassieu	Telefon Telefax E-Mail	+ 33 (0) 472 -791020 + 33 (0) 472 -791021 france@webermt.com
in Poland	WEBER Maschinentechnik Sp. zo.o. Ul. Jezioraki 86 02-863 Warszawa	Telefon Telefax E-Mail	+ 48 (0) 22 - 739 70 - 80 + 48 (0) 22 - 739 70 - 81 + 48 (0) 22 - 739 70 – 82 info@webermt.com.pl
In Tschechien	WEBER MT s.r.o. V Piskovne 2054 278 01 Kralupy nad Vitavou	Telefon E-Mail	+ 42 (0) 776 222 216 + 42 (0) 776 222 261 info@webermt.cz
in USA and Canada	WEBER MT 4717 Broadmoor Ave. SE Suite B Grand Rapids, MI 49512	Telefon Telefax E-Mail	+ 1(207) - 947 - 4990 + 1(207) - 947 – 5452 sales@webermt.us service@webermt.us

> Vibration plates

> Vibrating tampers

> Vibration rollers

> Joint cutters

> Internal vibrators and converters

> Rollers



Weber MASCHINENTECHNIK GmbH

Im Boden

57334 Bad Laasphe - Rückershausen

Telephone + 49 27 54 / 398 0 - fax +49 27 54 / 398 101